



CHA530

2-Way horn loudspeaker 5"

Highlights:

- IP66 Ingress protection
- 30 Watt RMS power
- Multi-tapping 100V line transformer
- 5" Low frequency loudspeaker
- 1" HF Horn tweeter

The CHA530 is a 2-way horn loaded loudspeaker which is designed for long-throw, full range reproduction of music and speech in a wide variety of indoor and outdoor applications.

The construction is composed of a 1" high frequency compression driver and a 5" mid/low frequency driver. The selection of high-quality components and acoustic engineering craftsmanship makes the CHA530 significantly better performing than other traditional horn speakers. A smooth frequency response and high efficiency ensures an extraordinary clarity of speech and extended frequency response for music.

It features an RMS power handling of 30 Watt and a max power handling of 60 Watt. The sensitivity measures 98 dB while a maximum continuous SPL of 113 dB can be achieved. The frequency response (± 3 dB) starts from 110 Hz up to 16 kHz.

A multi-tapping line transformer allows the speaker to be used in 100 Volt and 70 Volt public address systems. It is connected using a waterproof rotatable AWX-5 connector whereby the desired power tap is selected depending on the rotation of the connector. Various power tapings for 30 Watt, 15 Watt, 7.5 Watt and 3.75 Watt are available.

The enclosure is constructed using high quality UV and impact resistant ABS materials and an included stainless steel mounting bracket allows secure mounting and tilting for perfect directional placement. This makes it comply with IP66 ingress protection requirements, resulting in a weatherproof solution for permanent outdoor installation.

Connection of the loudspeaker is done using a screw terminal block connector located in a waterproof connection box on the rear of the speaker.

Applications:

- Retail
- Public facilities
- Corporate spaces
- Sport facilities



Properties:



Voltage:

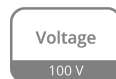

Usage:



System specifications:

| | | |
|----------------------------|------------------------|------------------------|
| Speaker type | | 2-way horn speaker |
| Max. Power | | 60 W |
| RMS Power | | 30 W |
| Line Transformer Tappings | 1 | 30 W / 333 Ω |
| | 2 | 15 W / 667 Ω |
| | 3 | 7.5 W / 1330 Ω |
| | 4 | 3.75 W / 2660 Ω |
| Sensitivity (1W/1m) | | 98 dB |
| Sound Pressure (Max. W/1m) | @ 100 V | 113 dB |
| Frequency | Response (\pm 3 dB) | 110 Hz - 16 kHz |
| Crossover | Type | Passive built-in |
| Dispersion | Horizontal | 110° |
| | Vertical | 60° |
| Ingress Protection rating | | IP66 |
| Drivers | | 5" MF / LF Woofer |
| | HF | 1" HF Horn tweeter |
| Connection | | AWX5™ waterproof |

Product Features:

| | | |
|---------------------|----------|--------------------------------|
| Dimensions | | 310 x 215 x 330 mm (W x H x D) |
| Weight | | 4.7 kg |
| Construction | | Impact & UV resistant ABS |
| Colours | | Light grey (RAL7035) |
| Mounting & handling | | Powder coated steel |
| Accessories | Included | Mounting bracket |

Acoustical data graphs:

Horizontal Polars:

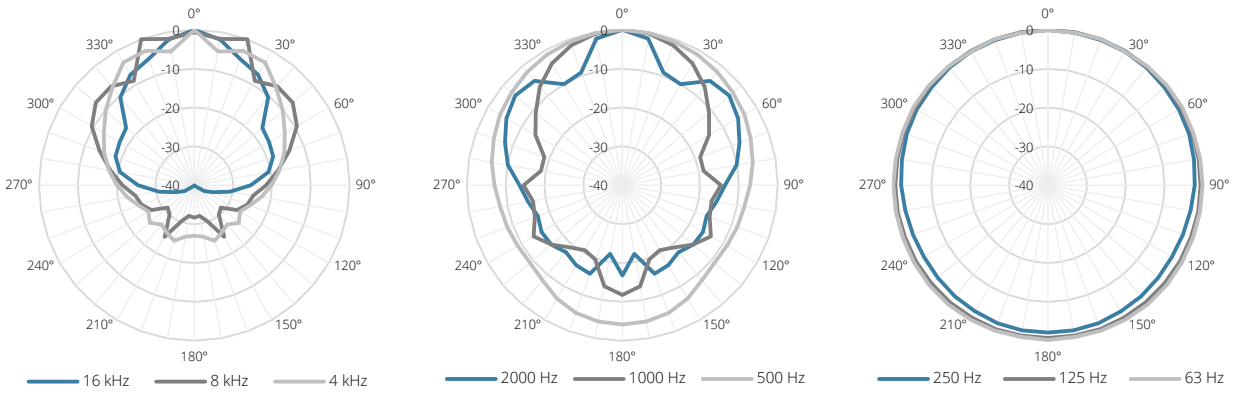

Vertical Polars:

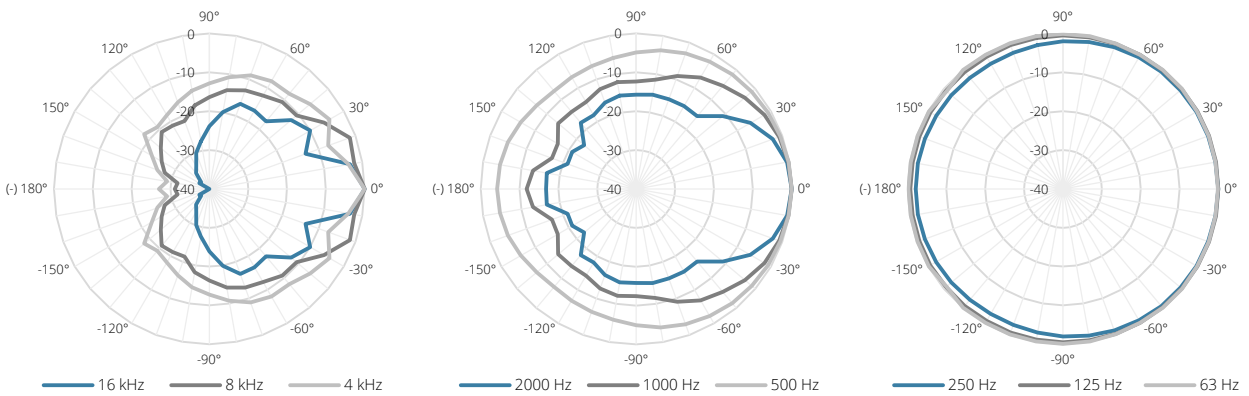

Sensitivity:

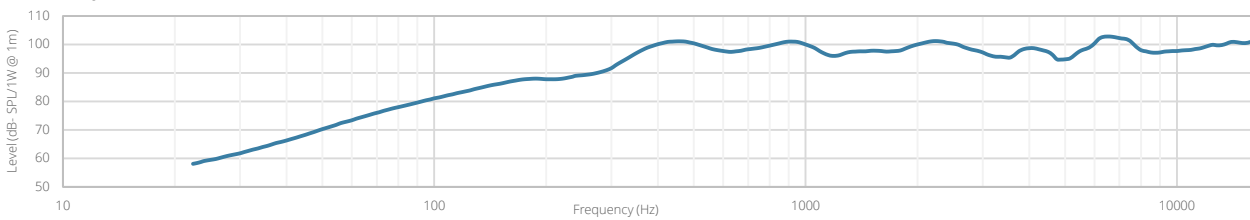

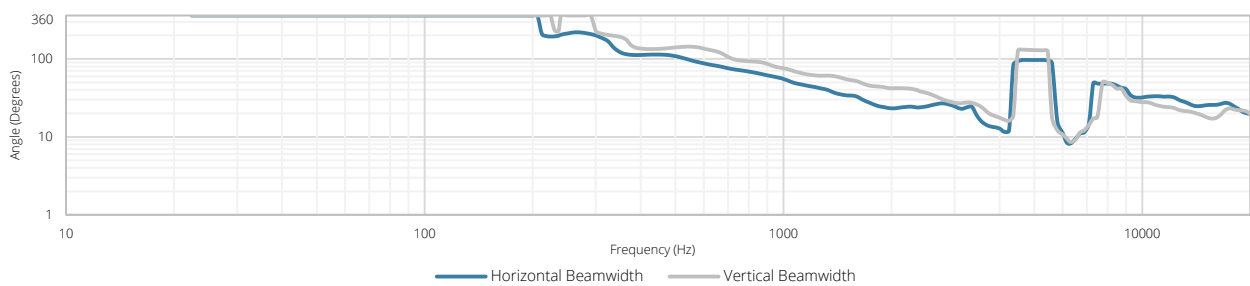

Beamwidth (-3dB):

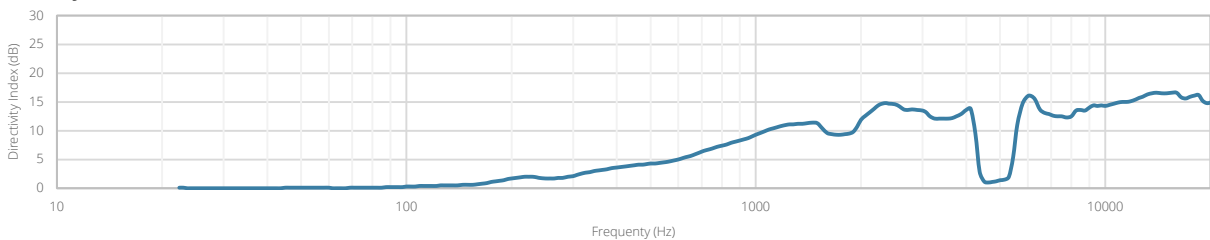

Directivity index:

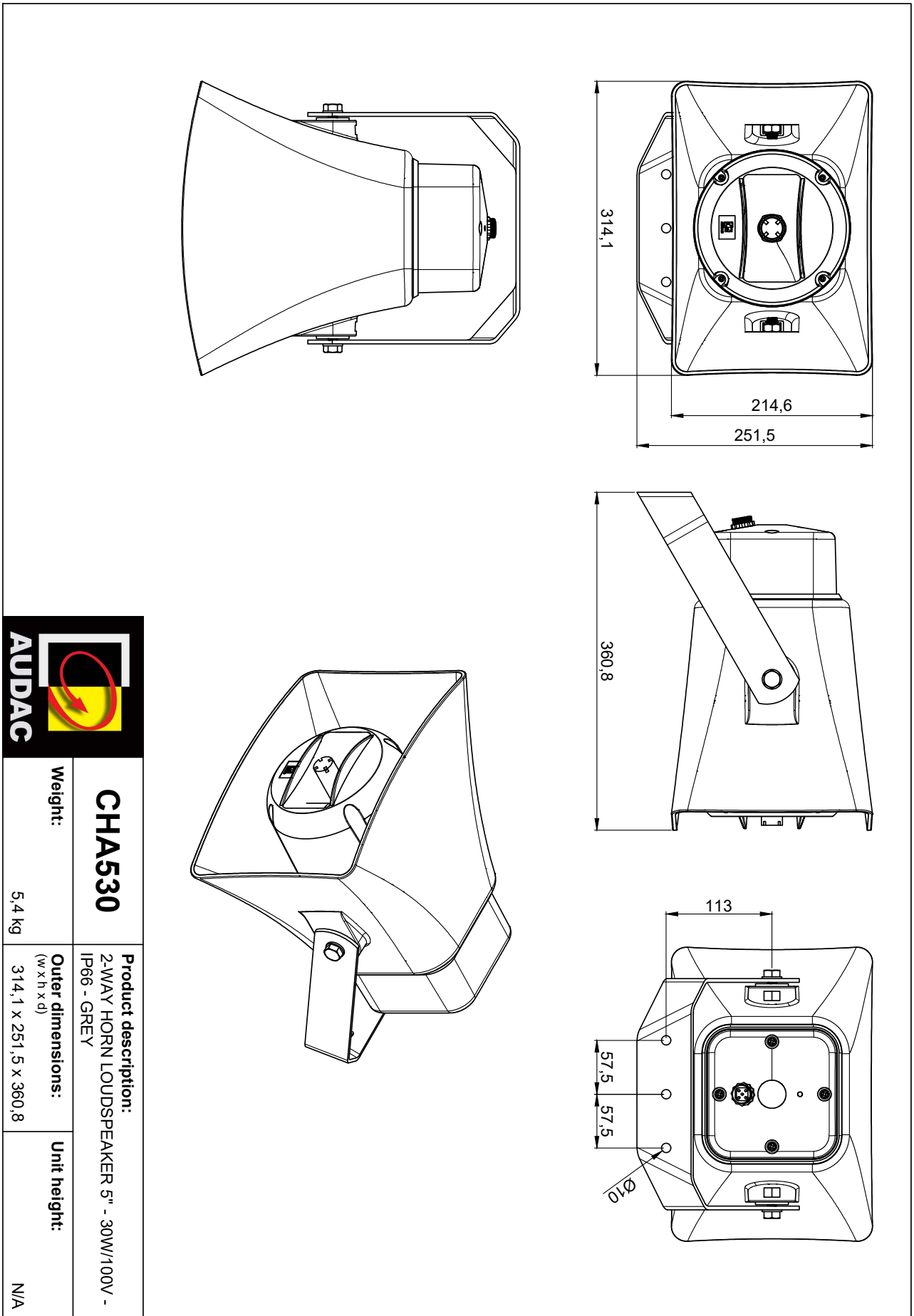



| | |
|---|--------------------------|
|  | |
| CHA530 | Weight: |
| 2-WAY HORN LOUDSPEAKER 5" - 30W/100V - IP66 - GREY | 5,4 kg |
| Product description: | Outer dimensions: |
| (w x h x d) | 314,1 x 251,5 x 360,8 |
| Unit height: | N/A |