



# HOSPITALITY & LEISURE

APPLICATIONS

**K**GEAR  
Smart Audio Solutions

**K**-ARRAY  
Unique Audio Solutions

**K**SCAPE  
Merging Senses



# HOSPITALITY & LEISURE

## APPLICATIONS

Release January 2024

### **K-ARRAY** Unique Audio Solutions

P.  
16



Hotel and Resort

18



Restaurants and Cafes

26



Fitness & Wellness Centers

38



Cruise Ships

48



Casinos

52



Nightclubs & Lounges

56

### **KGEAR** Smart Audio Solutions

P.  
68



Hotel and Resort

70



Restaurants and Cafes

74



Fitness & Wellness Centers

84



Casinos

90



Nightclubs & Lounges

94

### **KSCAPE** Merging Senses

P.  
98



Hotel and Resort

100



Restaurants and Cafes

108



Fitness and Wellness Centers

116

## **ENHANCING GUEST EXPERIENCES THROUGH ADVANCED AUDIO SOLUTIONS**

Perfect for Hospitality & Leisure applications, K-ARRAY's solutions deliver sound reinforcement, noise control, and speech clarity.

Easy to set up with products that are appreciated by sound designers, architects, and tech installers.

Suitable for hotels, bars, fitness centres, cruise ships, and casinos, K-ARRAY's technology offers exceptional sound and stunning design while setting the perfect atmosphere.

## OPTIMISING AMBIENCE

With K-ARRAY's Smart Audio Solutions

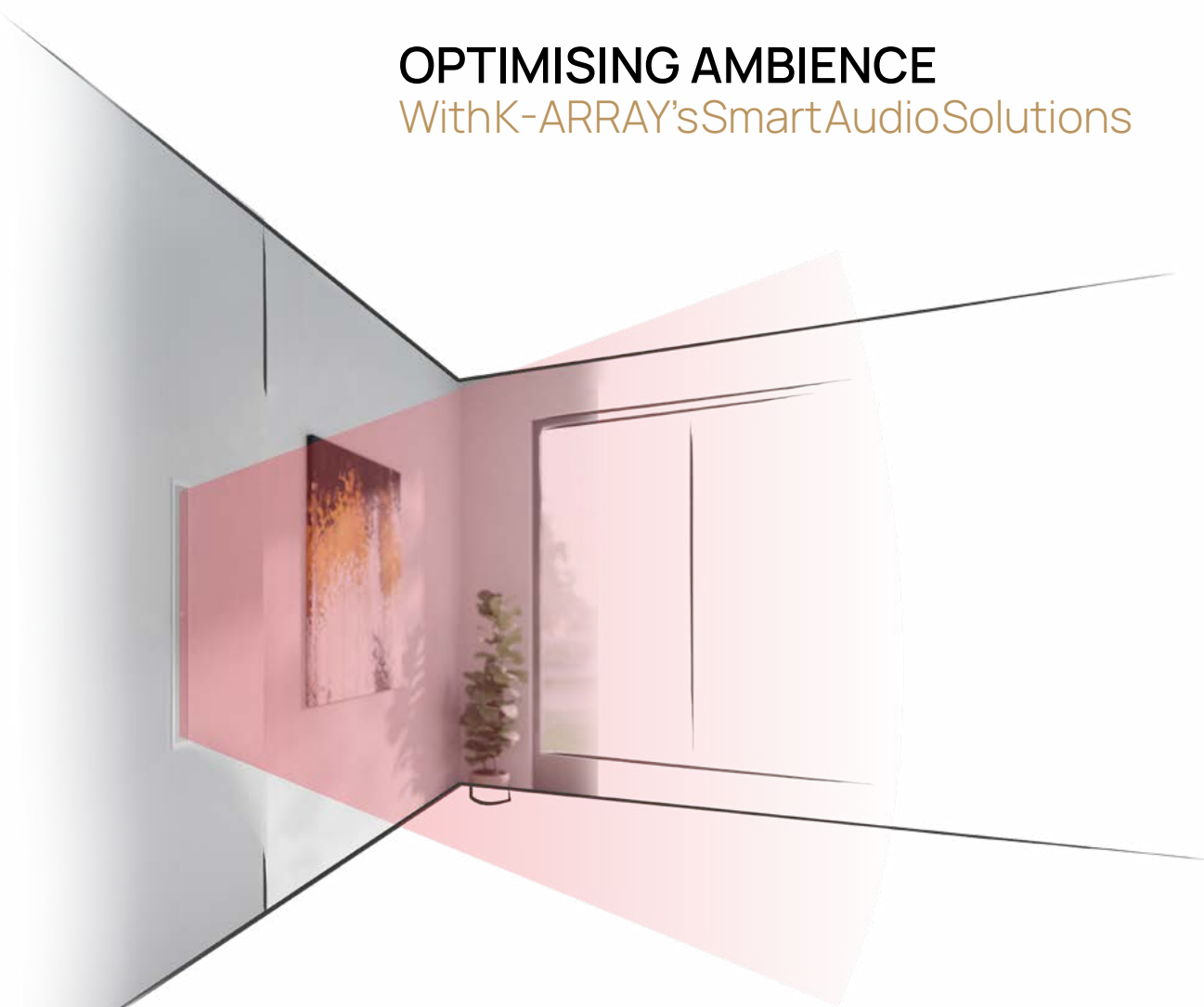

For an unforgettable guest experience, K-ARRAY's audio solutions seamlessly blend design, functionality, and sound quality. Their customizable, inconspicuous systems cater to a variety of leisure spaces. Using Pure Array Technology, they provide even, consistent sound, perfect for creating the ideal ambience.

## COMBINING AUDIO COVERAGE, ENGAGING CONTENT And Cost Saving



K-ARRAY's smart audio solutions deliver quality sound and sleek design, eliminating bulky loudspeakers. Used with wireless audio distribution, they enable personalized sound zones throughout buildings.

Their smart amplifiers and accessible interfaces allow for customizable systems, helping professionals balance background noise and audio levels, saving on extra hardware.



WI-FI



USB  
MULTIMEDIA PLAYER



ETHERNET



OPTICAL  
INPUT

OSC v.17.8

Bluetooth



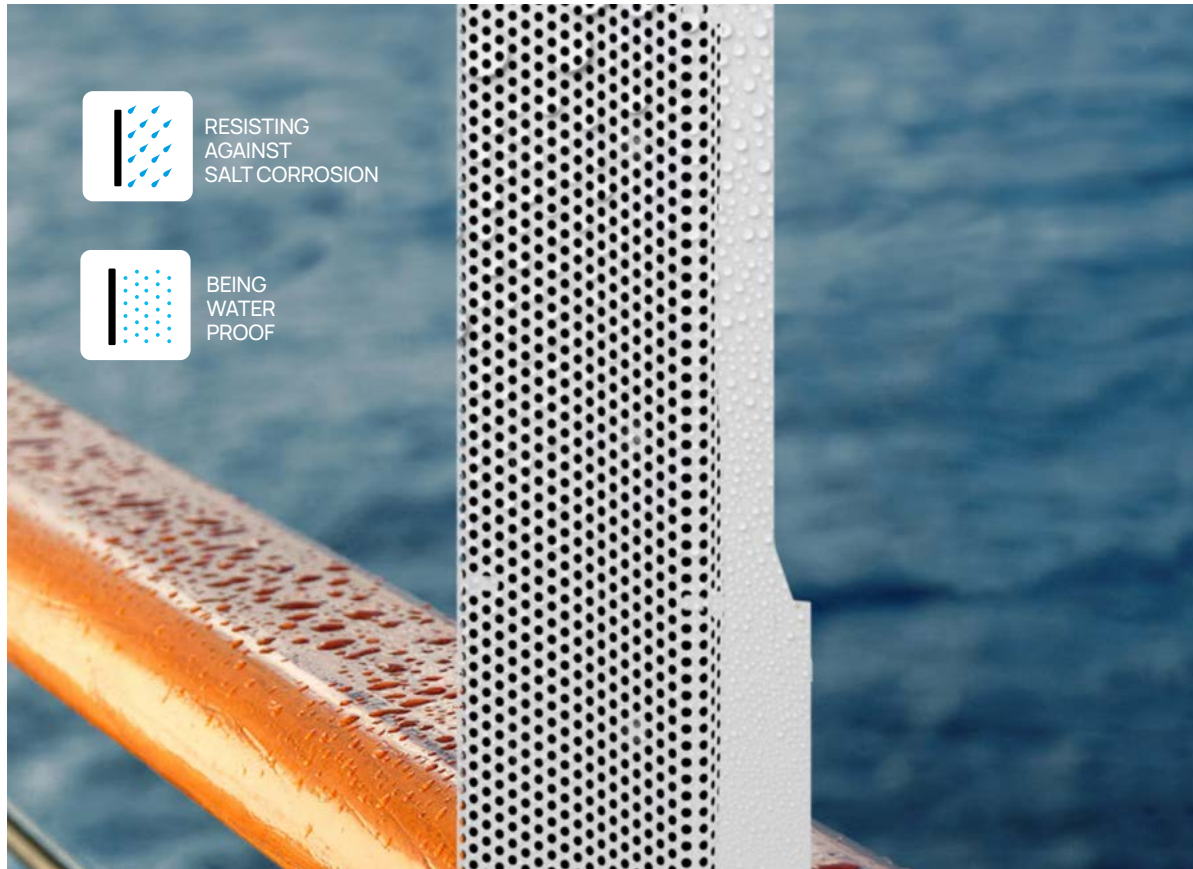

## **DURABLE AUDIO OPTIONS** For Outdoor & Marine Space

K-ARRAY's durable audio solutions address the challenges of outdoor leisure spaces. Their compact, high-quality loudspeakers ensure optimal coverage and longevity. Built with water and salt-resistant materials, their specifically treated loudspeakers and subwoofers are perfect for marine settings, minimizing waste from replacements. K-ARRAY's Pure Array Technology offers quality, directional sound, reducing audio spill and outdoor noise pollution.

## **SOLUTIONS** **FOR CHALLENGING** **OR EXISTING INSTALLATIONS**

Refitting audio equipment in hospitality and leisure settings can be challenging, especially when dealing with historic or listed buildings. K-ARRAY's point-source loudspeakers simplify wiring and offer outstanding sound.

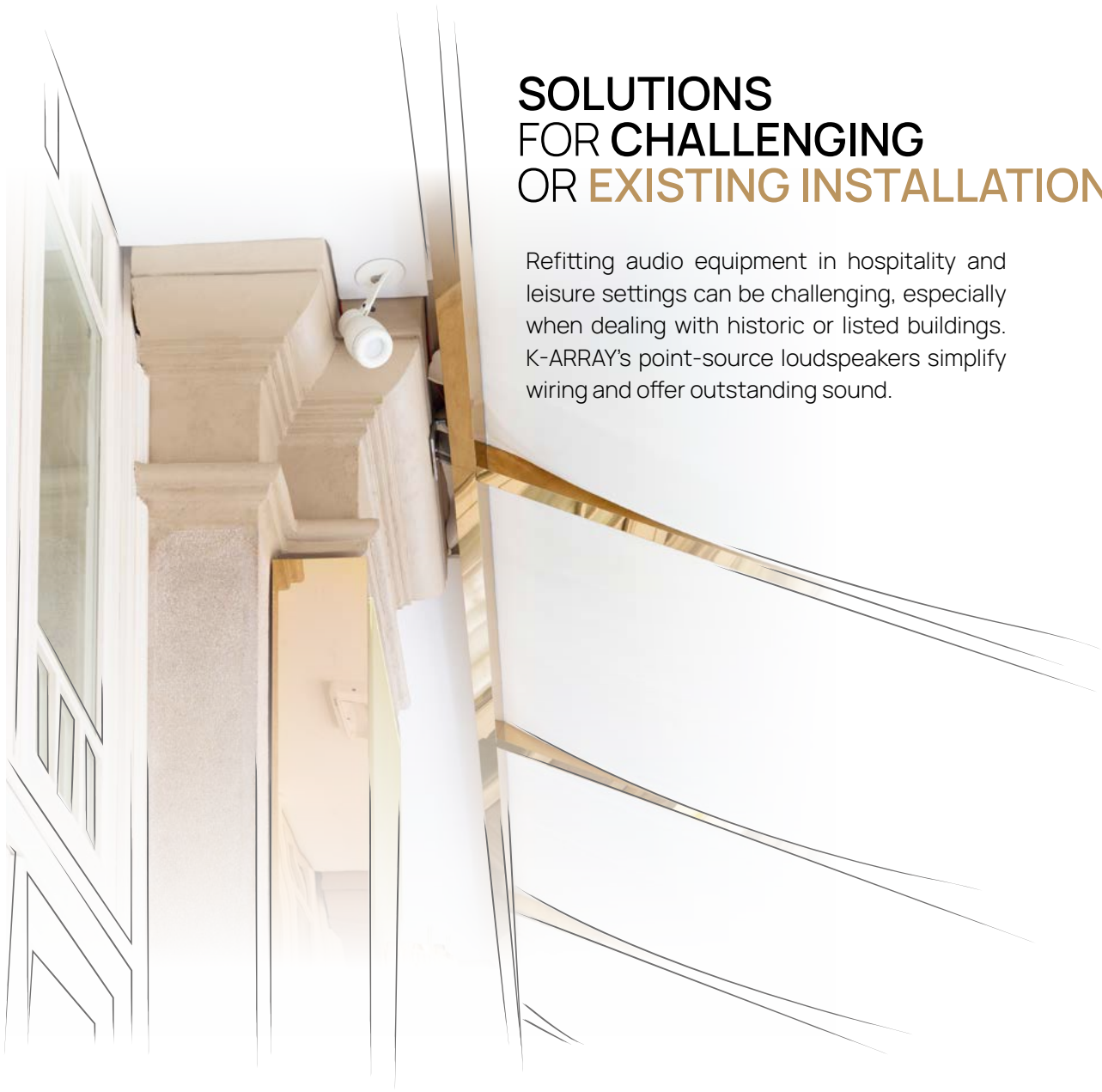



## COMMUNICATION AND SOUND INTELLIGIBILITY

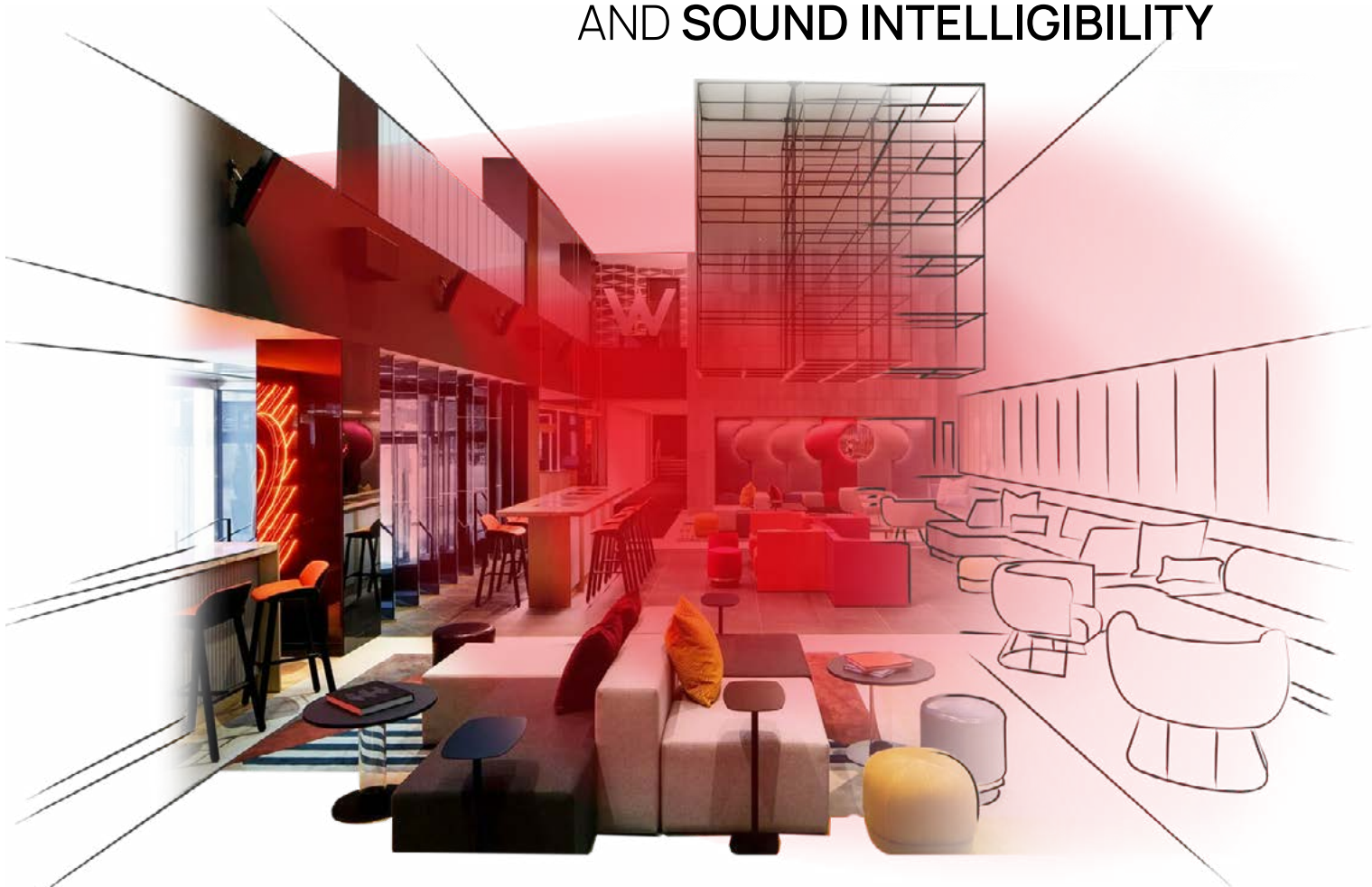

Clear communication is vital in hospitality for a positive guest experience. K-ARRAY's products optimize speech intelligibility from hotel announcements to fitness classes.

Buildings needing voice alarm systems must comply with EN 54. Choosing EN 54-24 compliant audio equipment ensures adherence to industry regulations, providing a secure environment.

## FEEL THE LIGHT

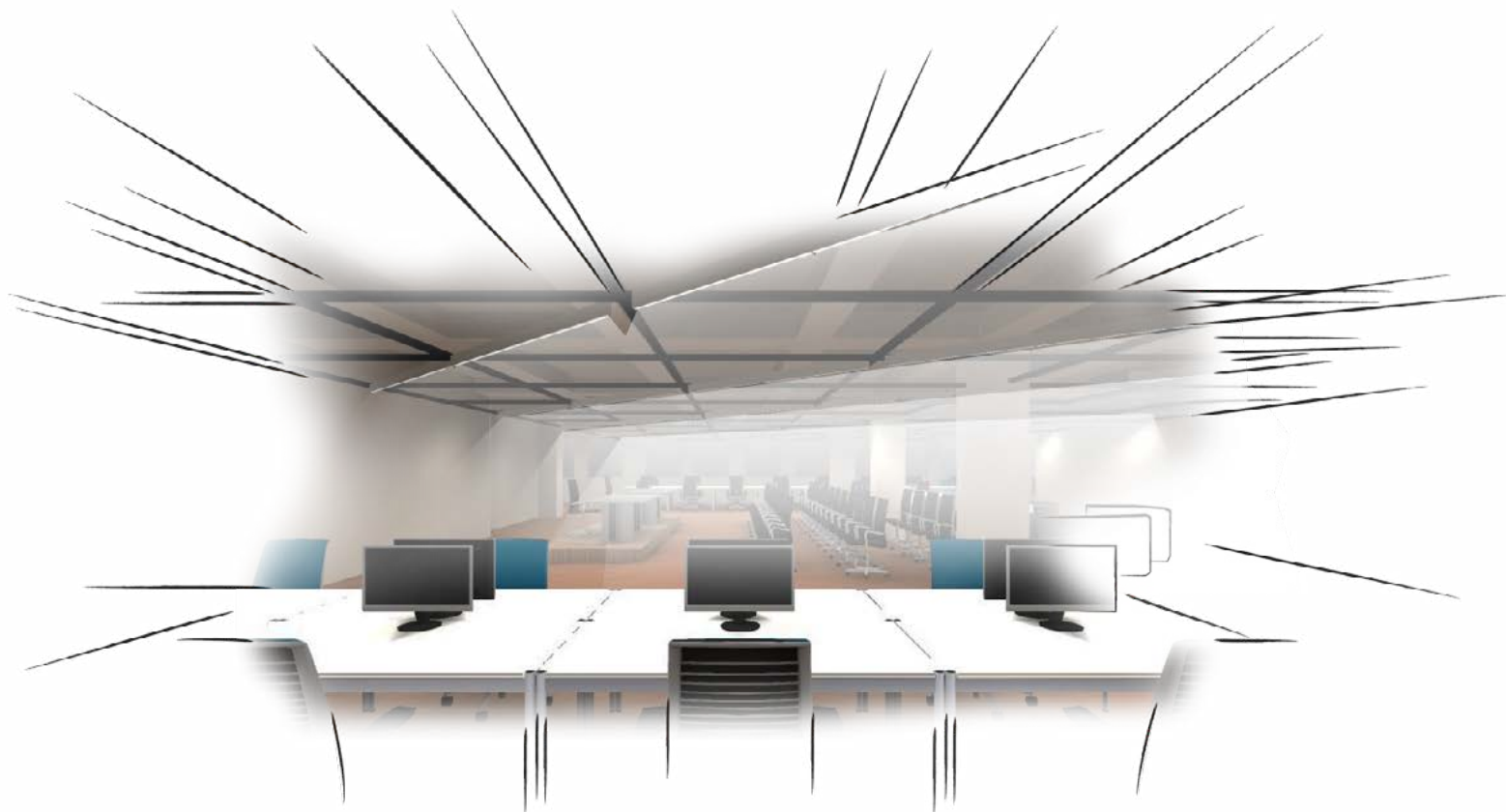

Light significantly impacts our daily activities and how we perceive the spaces in which we live and work. A proper lighting design allows for the creation of comfortable and aesthetically pleasing environments. Harmony between architectural spaces and lighting is crucial, and to achieve this, cutting-edge lighting products are required.

KSCAPE systems provide the perfect solution to this challenge, thanks to their wide range of mounting options, optics, and control systems. They enable the creation of integrated, engaging, and well-designed spaces



PERFECT  
AUDIO  
QUALITY



HIGH  
LED  
PERFORMANCE



**MATCH  
THE COMBINATION**  
Between the **audio**  
and the **light** technology

KSCAPE is committed to creating integrated systems of various technologies, offering customers, integrators, and specifiers unique and cutting-edge products.

Creating a unified ecosystem between environmental audio and lighting is an engaging and exciting challenge.

The RAIL system allows for the creation of an emotional and immersive environment with a single product in which sound and light coexist and seamlessly integrate into the architectural space.

**HOSPITALITY & LEISURE**  
AUDIO SOLUTIONS







# EcoSystem application

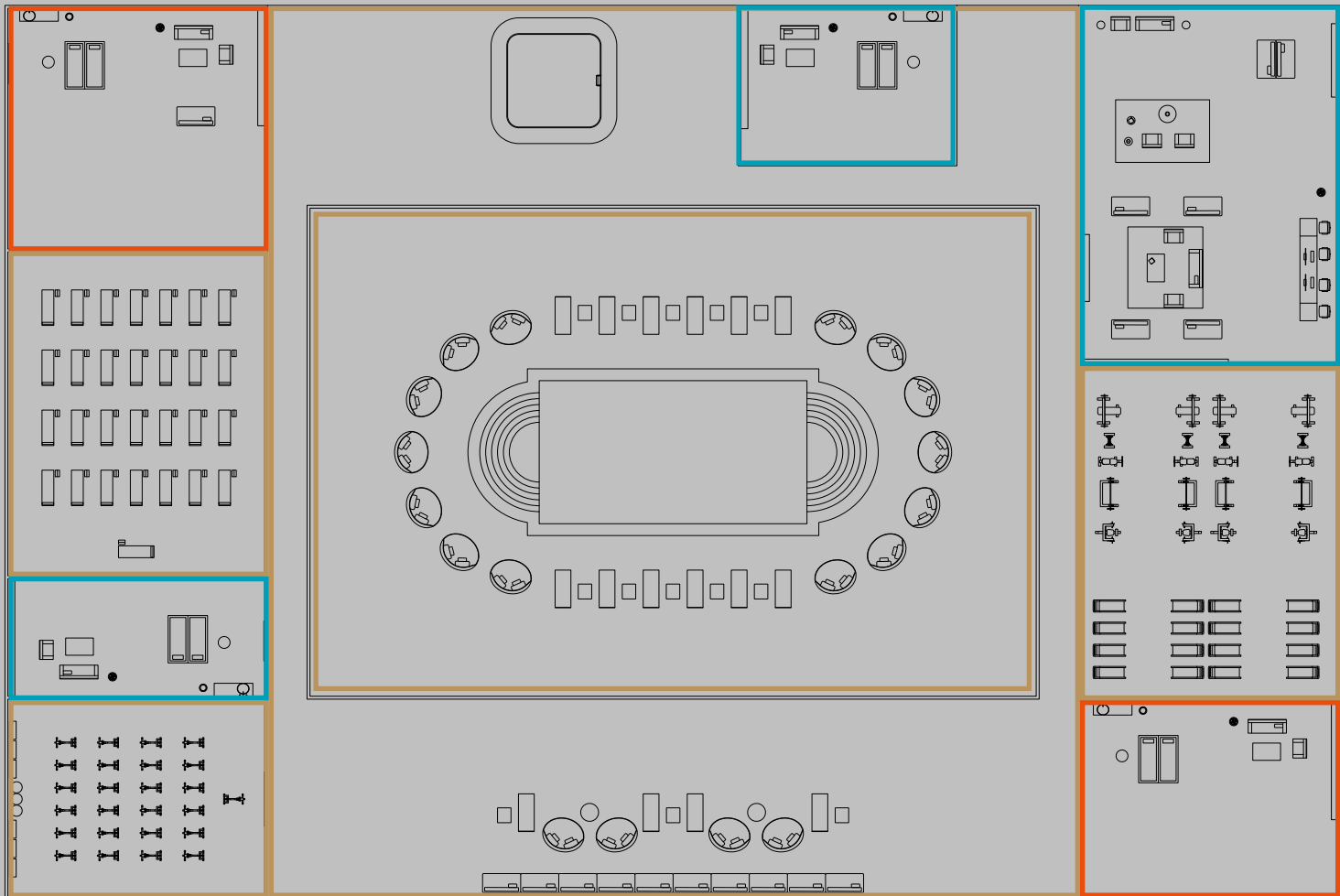

This configuration shows an example of a wellness and fitness installation

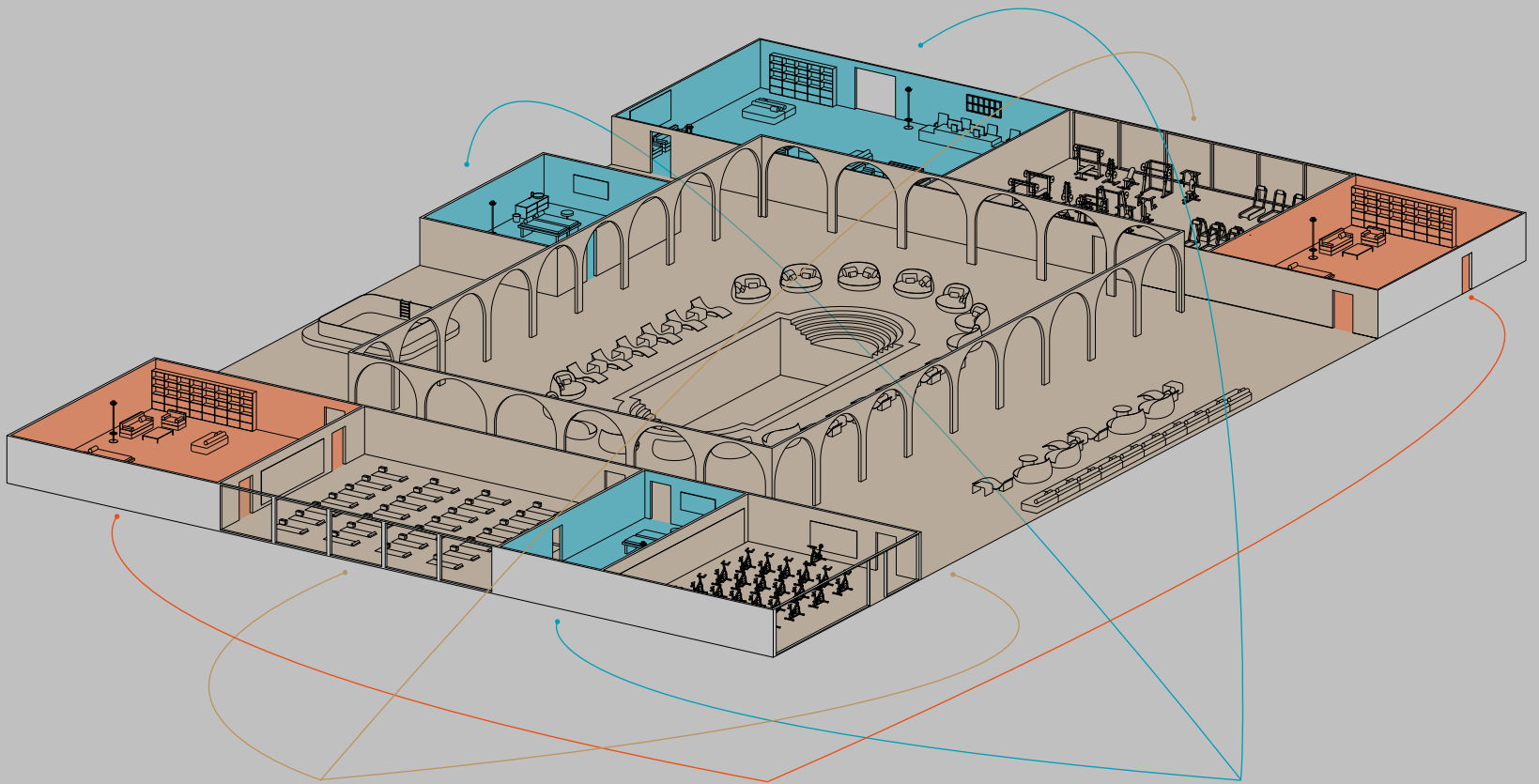

**K-ARRAY**  
Unique Audio Solutions

**KGEAR**  
Smart Audio Solutions

**KSCAPE**  
Merging Senses



# K-ARRAY

Unique Audio Solutions



Hotel and Resort

P.  
18



Restaurants and Cafes

26



Fitness & Wellness Centers

38



Cruise Ships

48



Casinos

52



Nightclubs & Lounges

56



## Enhance Your Guests' Experience with **K-ARRAY**

Creating the perfect ambiance for guests is crucial. Audio plays a significant role in shaping their overall experience, whether they are staying at a hotel, dining at a restaurant, or enjoying a workout at a fitness center. Facility managers, system integrators, audio tech installers, AV integrators, architects, event planners, owners, and interior Designers face unique challenges in designing audio systems that cater to various needs and preferences, while maintaining aesthetic appeal and seamless integration with the environment. K-ARRAY offers versatile and innovative audio solutions to help professionals create the ultimate experience for their guests.

## HOSPITALITY & LEISURE

AUDIO SOLUTIONS



# Hotels and Resorts

Large-scale hospitality settings with multiple rooms across floors require versatile solutions. K-ARRAY's slim loudspeakers and subwoofers integrate seamlessly for a stylish atmosphere, and sound masking prevents audio bleed from communal areas. Their discreet in-wall loudspeakers and line array systems offer high-quality sound for guest rooms, event spaces, and clear staff announcements.



## LOBBIES & LOUNGES





Hotels and Resorts

# LOBBIES & LOUNGES

## Configuration 3

180 sq m / 323 sq ft

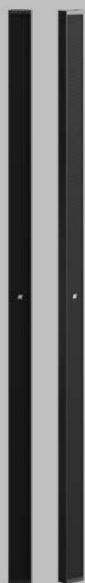
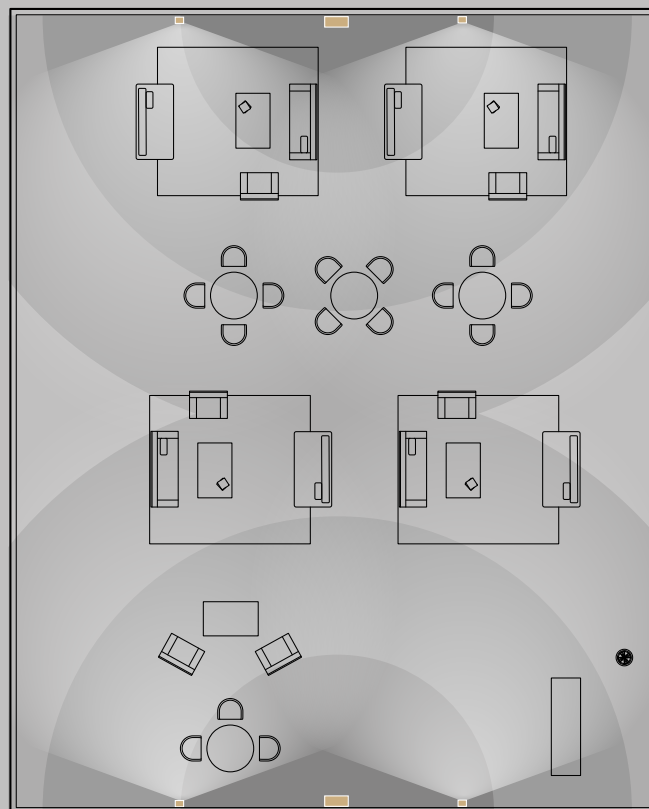
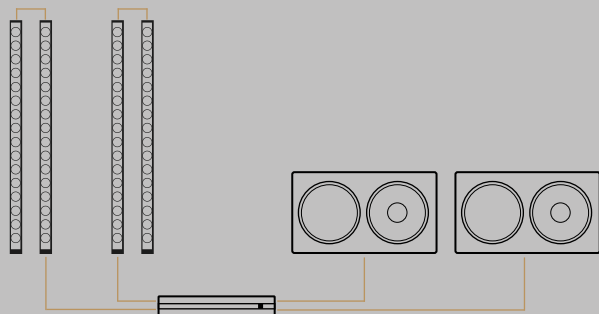

**Vyper-KV102 II**

Speaker  
40 x 1000 x 22 mm  
1,8 kg



**Rumble-KU210**

Subwoofer  
500 x 282 x 151 mm  
11 kg

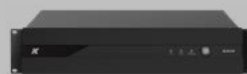

**Kommander-KA14 I**

Amplifier  
430 x 87 x 430 mm  
6 kg



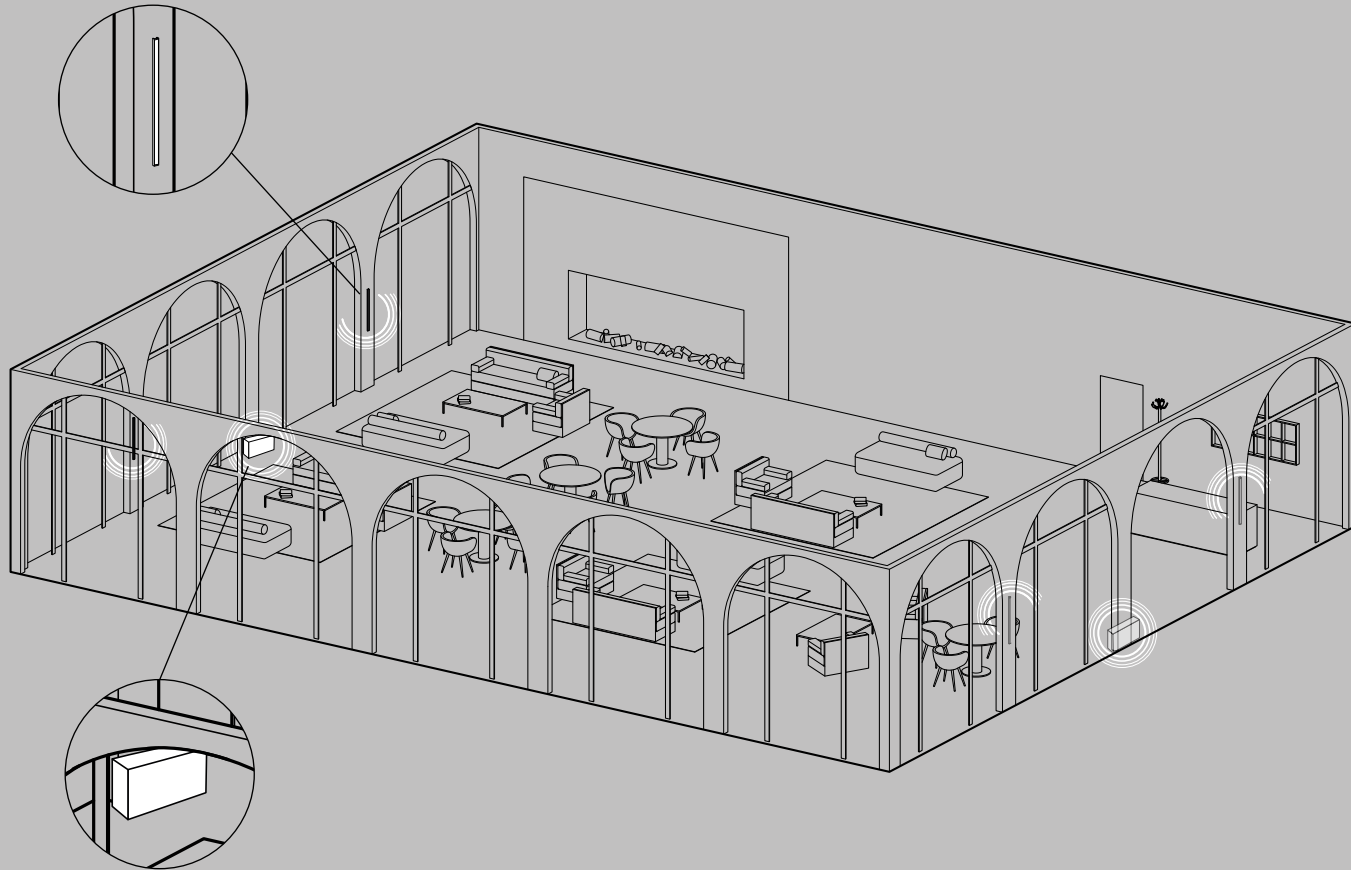

### Configuration 3

180 sq m / 1937 sq ft

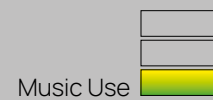

Conf.	Area	System	Accessories		
1	40 sq m (430 sq. ft.)	1x <b>Azimut-KAMUT2L I</b> (2x Lizard-KZ14 + 1x Rumble-KU44 I + 1x Kommander-KA02 I)	1x <b>K-WF44</b> (OPT.)		
Conf.	Area	Speakers	Subwoofers	Amplifiers	Accessories
2	90 sq m (968 sq ft)	4x <b>Vyper-KV25 II</b>	2x <b>Rumble-KU26</b>	1x <b>Kommander-KA04</b>	1x <b>K-WF26</b> (OPT.)
3	180 sq m (1937 sq ft)	4x <b>Vyper-KV102 II</b>	2x <b>Rumble-KU210</b>	1x <b>Kommander-KA14 I</b>	1x <b>K-WF210</b> (OPT.)









Hotels and Resorts

# ROOMS

Configuration 1

15 sq m / 161 sq ft

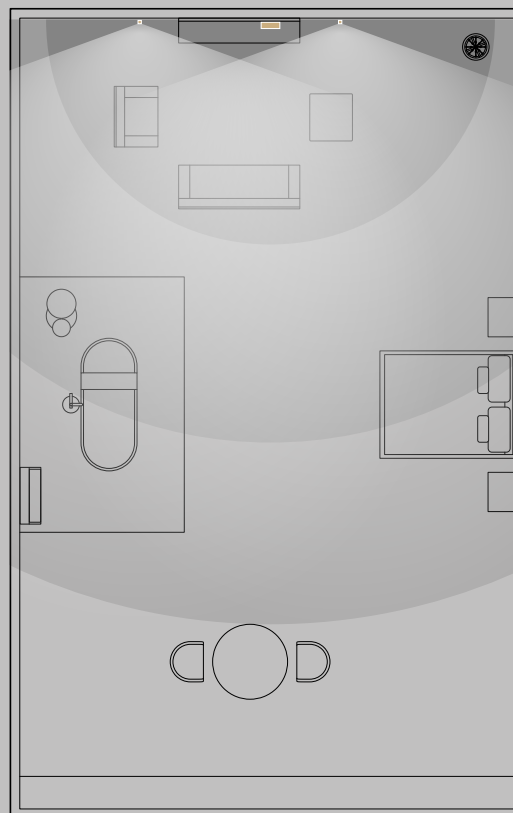
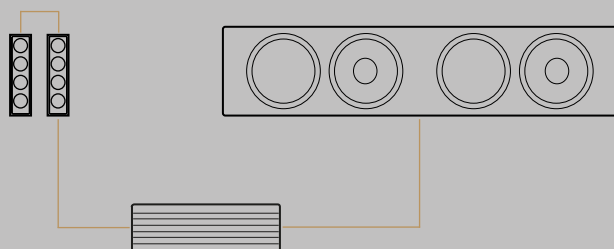

**Azimut-KAMUT2L II**

System





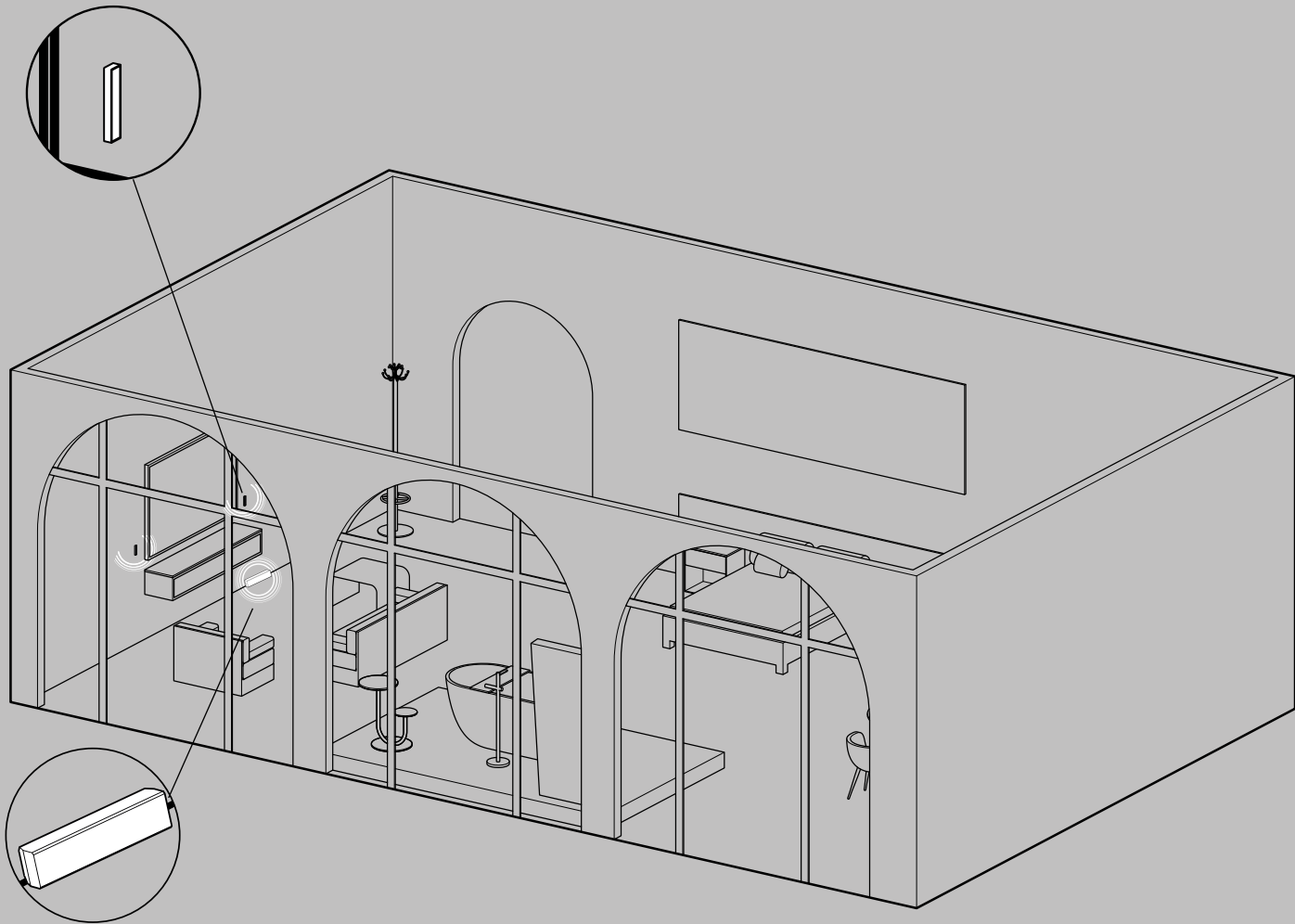

### Configuration 1

15 sq m / 161 sq ft

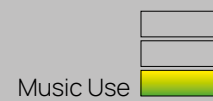

Conf.	Area	System	Accessories
1	15 sq m (161 sq. ft.)	1x <b>Azimut-KAMUT2L II</b> (2x Lyzard-KZ14 I + 1x Rumble-KU44 I + 1x Kommander-KA02 I)	1x <b>K-WF44</b> (OPT.)
2	50 sq m (538 sq. ft.)	1x <b>Azimut-KAMUT2V25 II</b> (2x Vyper-KV25 II + 1x Truffle-KTR26 I + 1x Kommander-KA02 I)	

## HOSPITALITY & LEISURE

AUDIO SOLUTIONS



# Restaurants and Cafes

Audio is key to a comfortable dining experience, but often has challenges like reflective surfaces and noise. K-ARRAY's solutions address these through aesthetic design, functionality, and quality sound. Their Pure Array Technology creates distinct audio zones, and outdoor loudspeakers offer durability. Their discreet and customizable loudspeakers integrate with decor and can be easily adjusted for different events and capacities.



## RESTAURANTS





Restaurants and Cafes

# DINING ROOMS

Configuration 2

120 sq m / 1291 sq ft

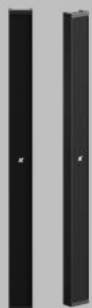
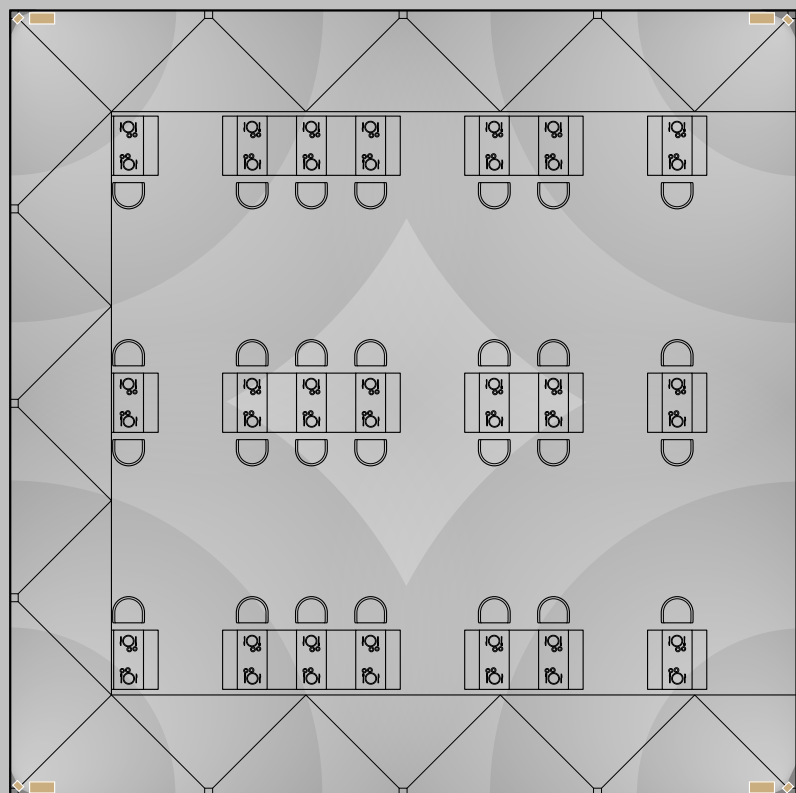
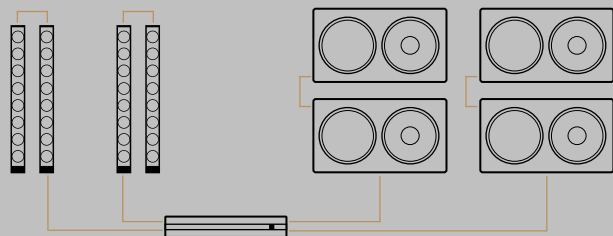

**Vyper-KV52 II**

Speaker  
40 x 1000 x 22 mm  
1,8 kg



**Rumble-KU26**

Subwoofer  
500 x 282 x 151 mm  
11 kg



**Kommander-KA14 I**

Amplifier  
430 x 87 x 430 mm  
6 kg



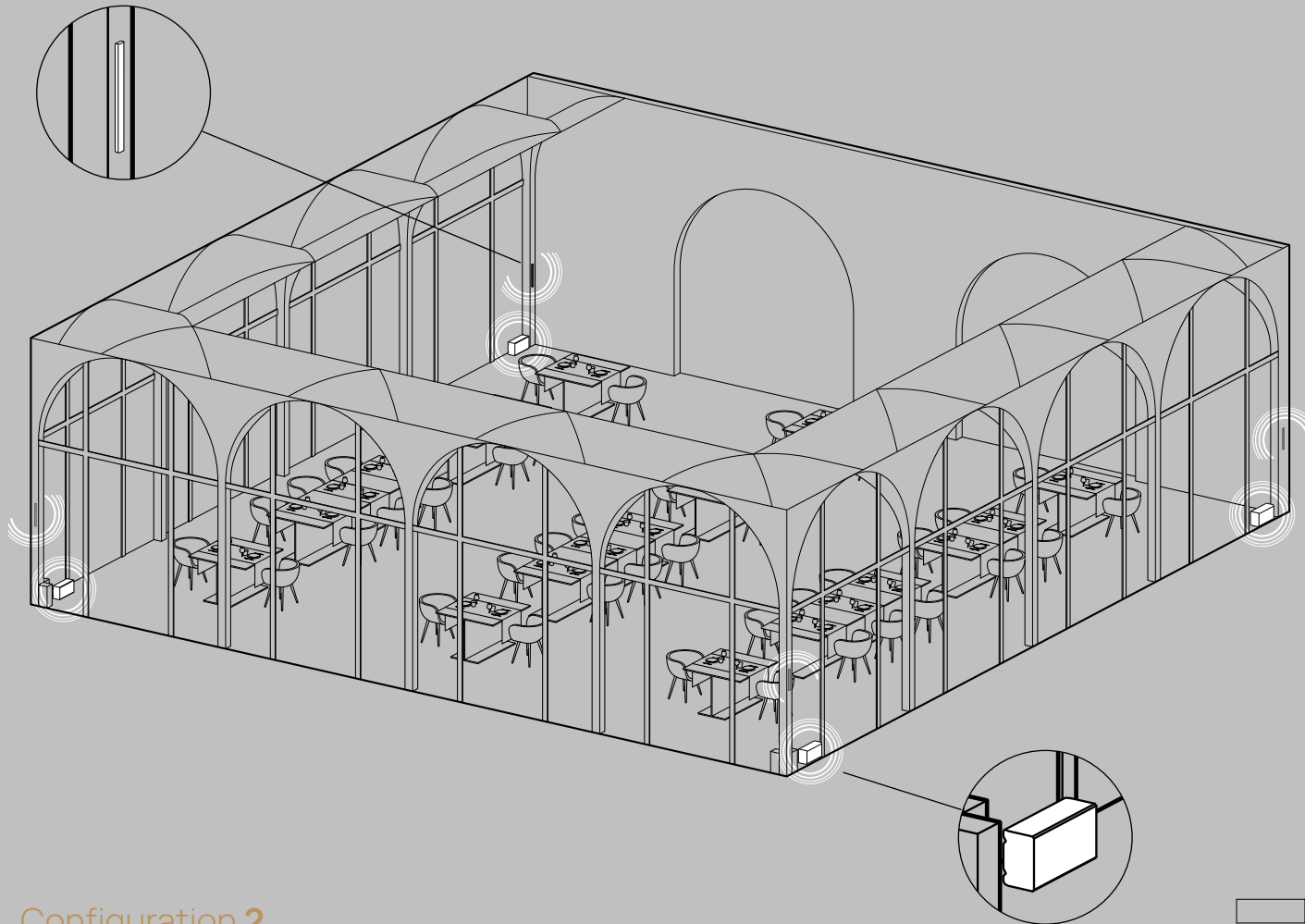

## Configuration 2

120 sq m / 1291 sq ft

Music Use



Conf.	Area	System	Accessories		
1	60 sq m (645 sq. ft.)	1x <b>Azimut-KAMUT2L 14 II</b> + 2x <b>Lyzard-KZ14 II</b> + 1x <b>Truffle-KTR25</b> (4x Lyzard-KZ14 + 2x Rumble-KU44 I + 1x Kommander-KA02 I)			
Conf.	Area	Speakers	Subwoofers	Amplifiers	Accessories
2	120 sq m (1291 sq ft)	4x <b>Vyper-KV52 II</b>	4x <b>Rumble-KU26</b>	1x <b>Kommander-KA14 I</b>	1x <b>K-WF26</b> (OPT.)
3	180 sq m (1937 sq ft)	4x <b>Vyper-KV102 II</b>	2x <b>Rumble-KU210</b>	1x <b>Kommander-KA14 I</b>	1x <b>K-WF210</b> (OPT.)





Restaurants and Cafes

# DINING ROOMS

## Configuration 3

400 sq m / 4305 sq ft

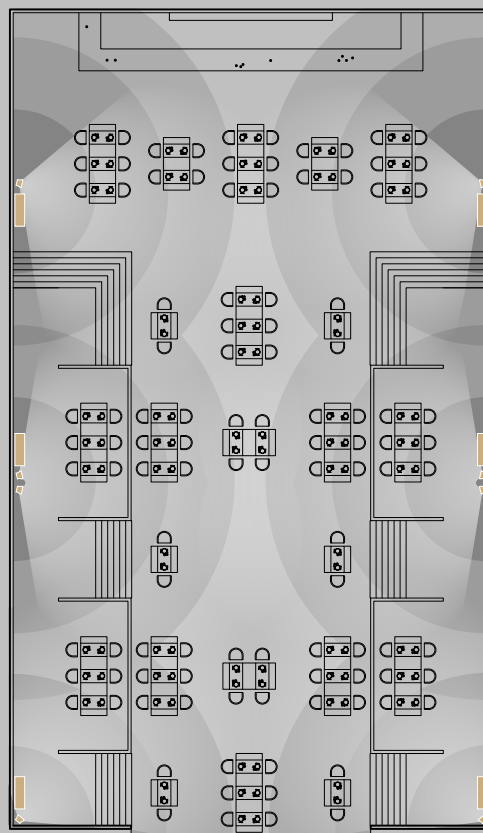
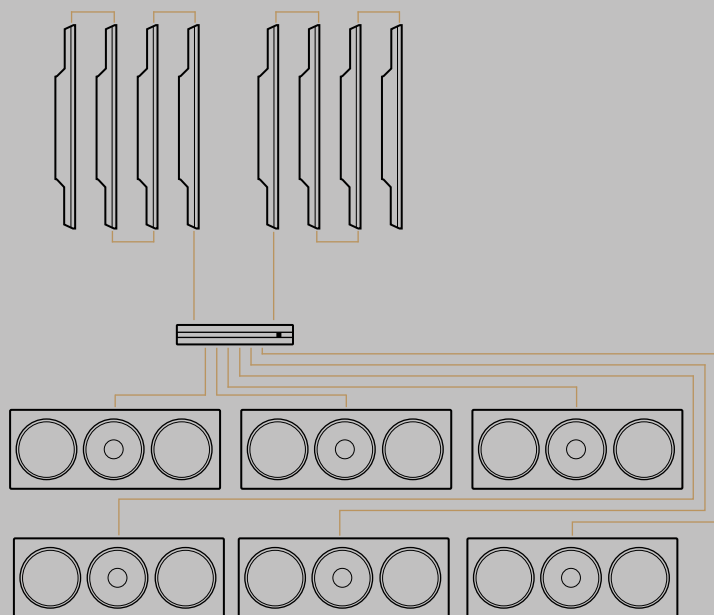

### **Kobra-KK102 I**

Speaker  
40 x 1000 x 22 mm  
1.8 kg

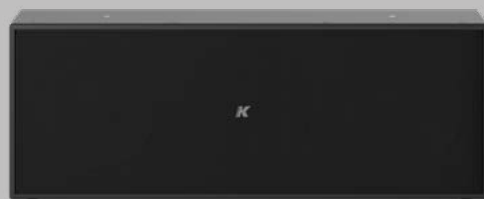

### **Rumble-KU315**

Subwoofer  
500 x 282 x 151 mm  
11 kg

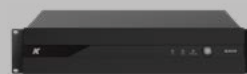

### **Kommander-KA208 I**

Amplifier  
430 x 87 x 430 mm  
6 kg



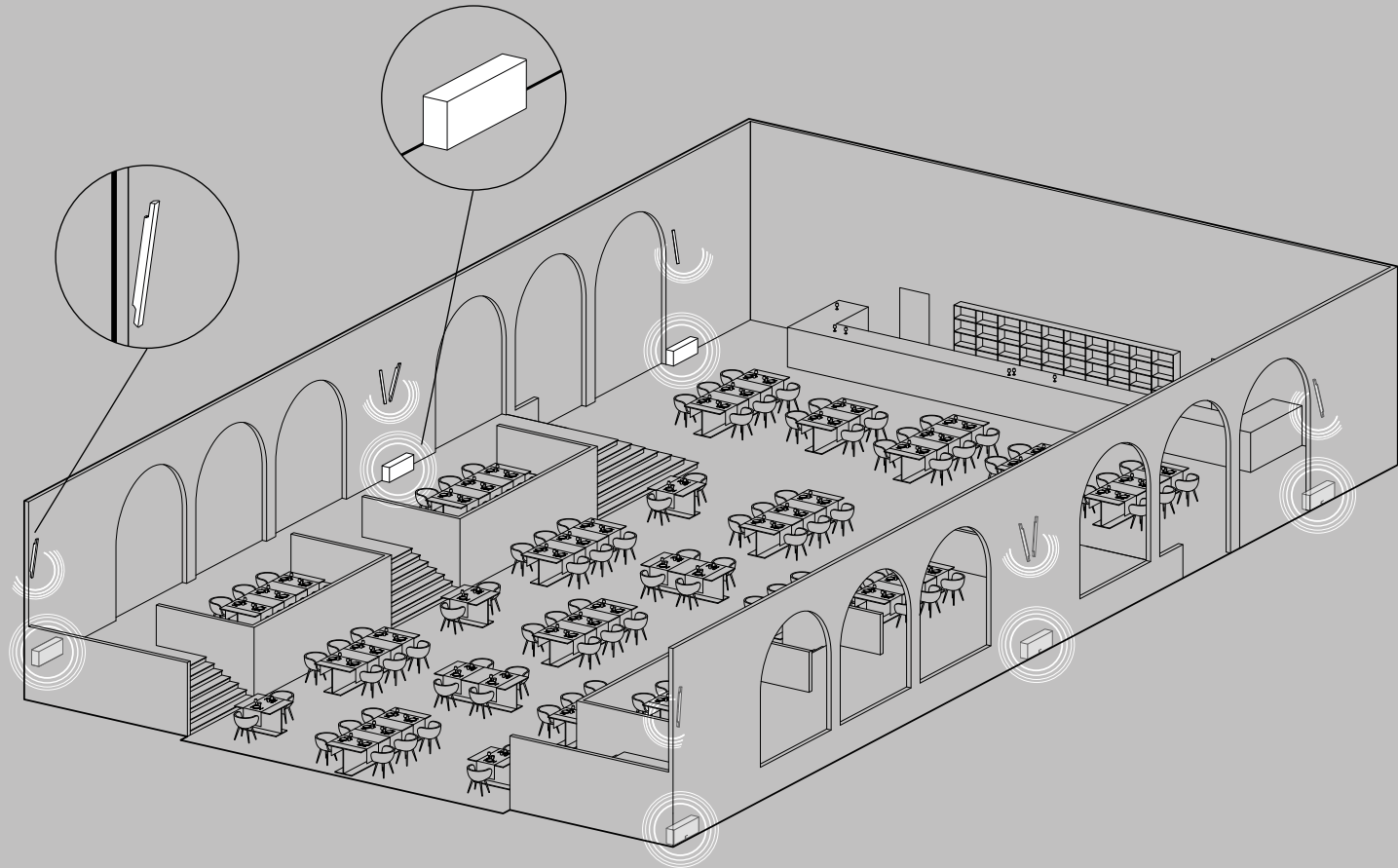

### Configuration 3

400 sq m / 4305 sq ft

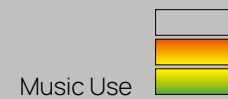

Conf.	Area	Speakers	Subwoofers	Amplifiers	Accessories
1	120 sq m (1291 sq ft)	4x <b>Vyper-KV102 II</b>	4x <b>Rumble-KU210</b>	1x <b>Kommander-KA34</b>	1x <b>K-WF210</b> (OPT.)
2	200 sq m (2152 sq ft)	6x <b>Kobra-KK102 I</b>	6x <b>Rumble-KU212</b>	1x <b>Kommander-KA104</b>	6x <b>K-WALL2L</b>
3	400 sq m (4305 sq ft)	8x <b>Kobra-KK102 I</b>	6x <b>Rumble-KU315</b>	1x <b>Kommander-KA208</b>	8x <b>K-WALL2L</b>









Restaurants and Cafes

# CAFES

Configuration 2

60 sq m / 645 sq ft

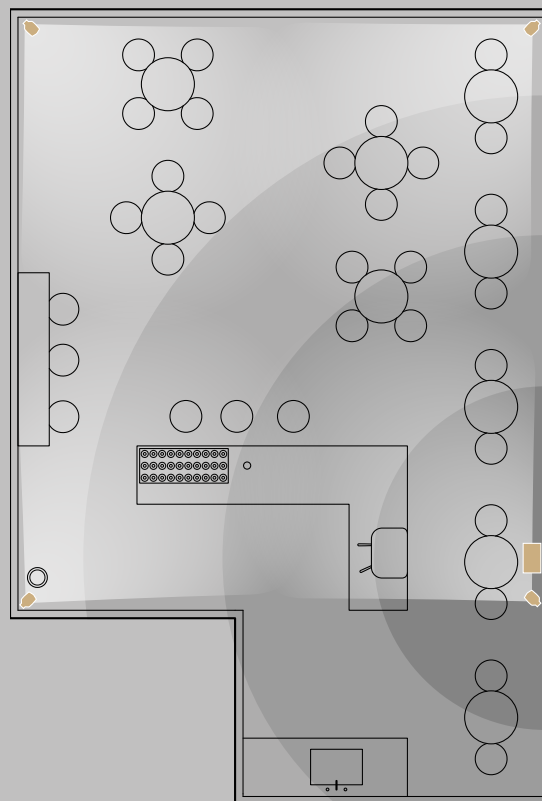
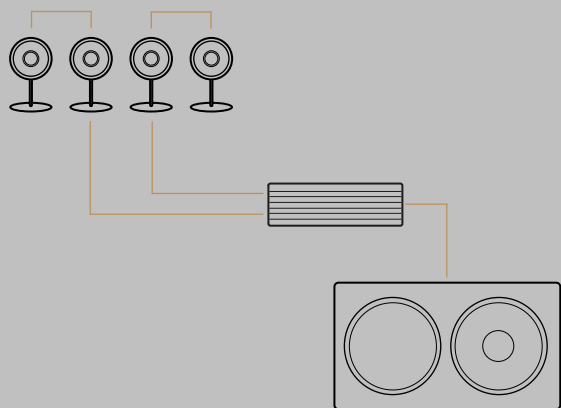

**Tornado-KT2**

Speaker  
40 x 1000 x 22 mm  
1,8 kg



**Rumble-KU26**

Subwoofer  
500 x 282 x 151 mm  
11 kg



**Kommander-KA04 I**

Amplifier  
430 x 87 x 430 mm  
6 kg



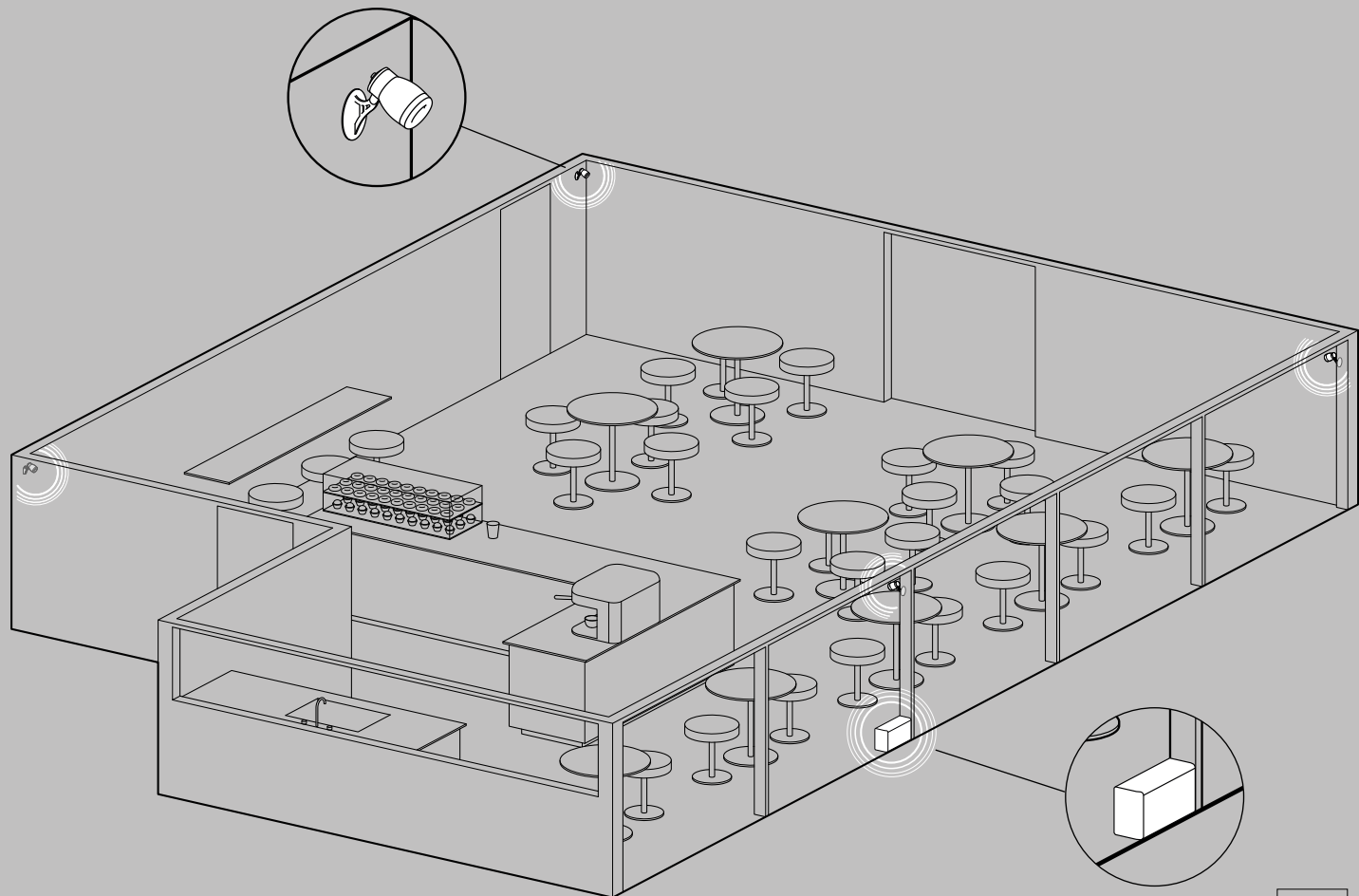

## Configuration 2

60 sq m / 645 sq ft

Music Use



Conf.	Area	System	Accessories
-------	------	--------	-------------

1	30 sq m (322 sq. ft.)	1x <b>Azimut-KAMUT2L 14 II</b> (2x Lyzard-KZ14 + 1x Rumble-KU44 I + 1x Kommander-KA02 I)	
---	--------------------------	---	--

Conf.	Area	Speakers	Subwoofers	Amplifiers	Accessories
-------	------	----------	------------	------------	-------------

2	60 sq m (645 sq ft)	4x <b>Tornado-KT2</b>	1x <b>Rumble-KU26</b>	1x <b>Kommander-KA04 I</b>	1x <b>K-WF26</b> (OPT.)
---	------------------------	-----------------------	-----------------------	----------------------------	-------------------------

3	90 sq m (968 sq ft)	6x <b>Tornado-KT2</b>	2x <b>Rumble-KU26</b>	1x <b>Kommander-KA04 I</b>	1x <b>K-WF26</b> (OPT.)
---	------------------------	-----------------------	-----------------------	----------------------------	-------------------------



Restaurants and Cafes

# BARS

Configuration 2

120 sq m / 1291 sq ft

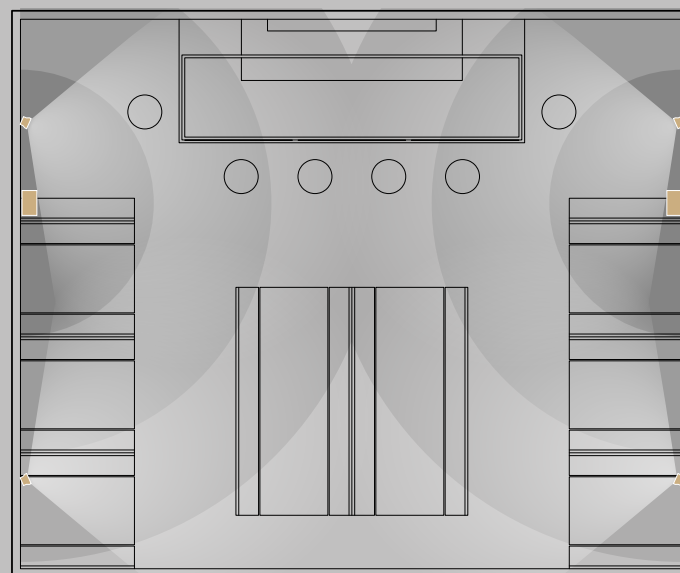
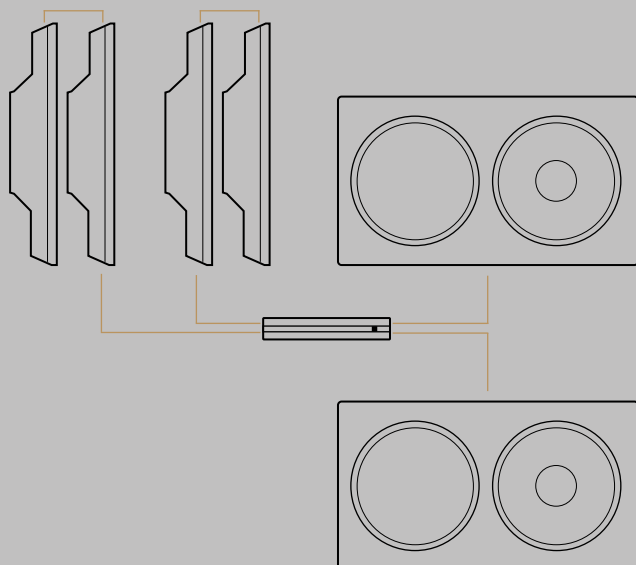

**Kobra-KK52 I**

Speaker  
40 x 1000 x 22 mm  
1,8 kg

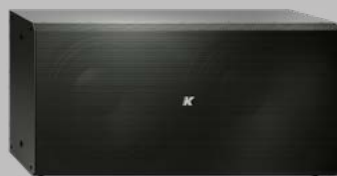

**Rumble-KU212**

Subwoofer  
500 x 282 x 151 mm  
11 kg



**Kommander-KA34 I**

Amplifier  
430 x 87 x 430 mm  
6 kg



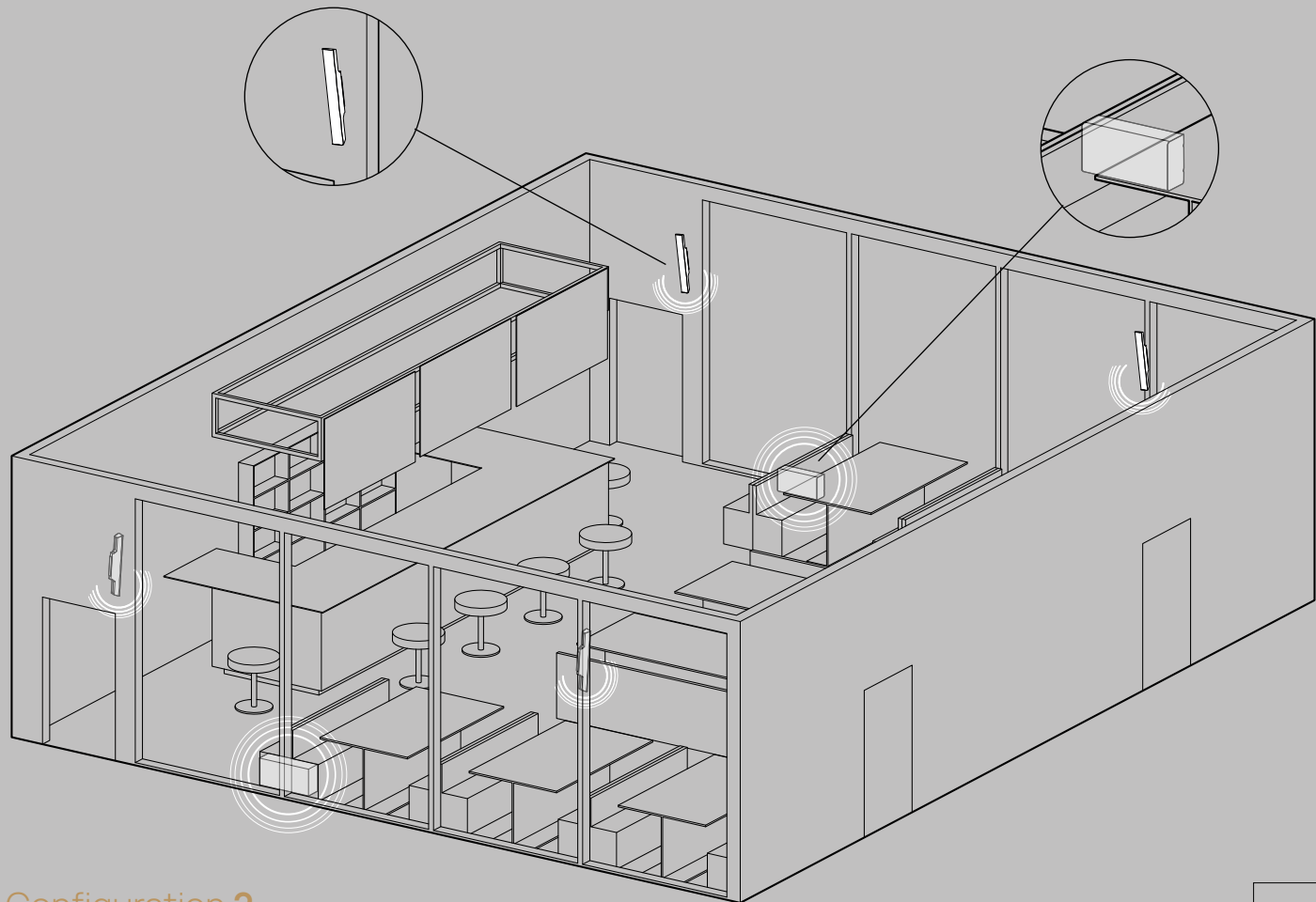

## Configuration 2

120 sq m / 1291 sq ft

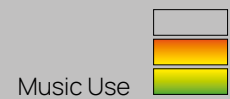

Conf.	Area	Speakers	Subwoofers	Amplifiers	Accessories
1	60 sq m (645 sq ft)	4x <b>Vyper-KV52 II</b>	2x <b>Rumble-KU210</b>	1x <b>Kommander-KA14 I</b>	1x <b>K-WF210</b> (OPT.)
2	120 sq m (1291 sq ft)	4x <b>Kobra-KK52 I</b>	2x <b>Rumble-KU212</b>	1x <b>Kommander-KA34</b>	4x <b>K-WALL2L</b>
3	180 sq m (1937 sq ft)	8x <b>Kobra-KK52 I</b>	4x <b>Rumble-KU212</b>	1x <b>Kommander-KA104</b>	8x <b>K-WALL2L</b>

## HOSPITALITY & LEISURE

AUDIO SOLUTIONS



# Fitness and Wellness Centers

In leisure settings, a flexible, quality audio system is vital. K-ARRAY's Slim Array Technology offers clear speech and even sound for fitness classes, while discreet in-ceiling loudspeakers provide unobtrusive background music. Their Marine products resist wear in aquatic environments. Existing systems can be easily upgraded with Domino full-range loudspeakers, eliminating extensive modifications, and improving audio performance.



## WELLNESS





Fitness and Wellness Centers

# WELLNESS AREAS

Configuration 1

15 sq m / 161 sq ft

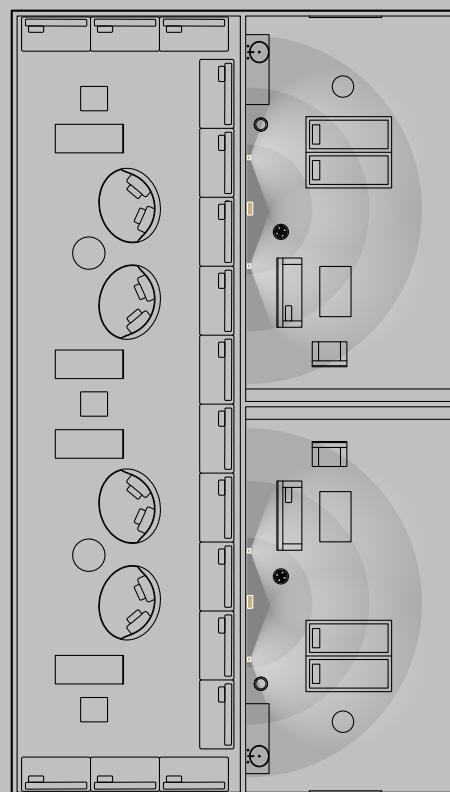
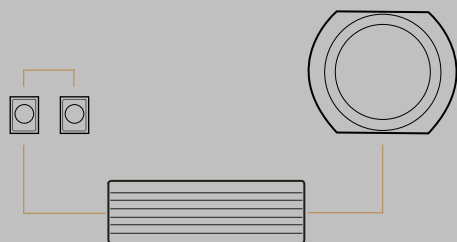

**Azimut-KAMUT2L1 II**

System





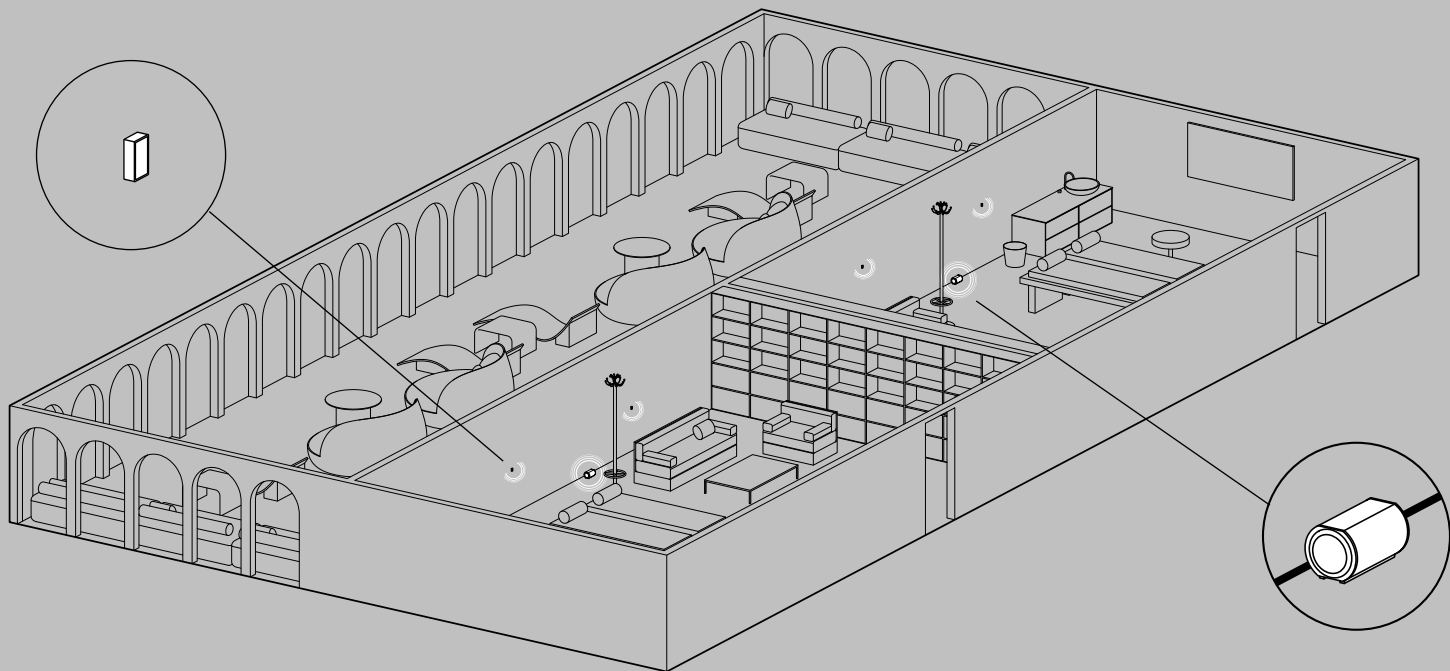

**Configuration 1**  
15 sq m / 161 sq ft

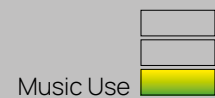

Conf.	Area	System	Accessories
1	15 sq m (161 sq ft)	1x <b>Azimut-KAMUT2L1 I</b> (2x Lyzard-KZ11 + 1x Truffle-KTR24 + 1x Kommander-KA02 I)	/
2	50 sq m (538 sq ft)	1x <b>Azimut-KAMUT2L14 I</b> + 2x <b>Lyzard-KZ14 II</b> (4x Lyzard-KZ14 + 1x Truffle-KTR25 + 1x Kommander-KA02 I)	/
3	150 sq m (1614 sq ft)	1x <b>Azimut-KAMUT2L14 I</b> + 4x <b>Lyzard-KZ14 II</b> + 1x <b>Truffle-KTR25</b> (4x Lyzard-KZ14 + 1x Truffle-KTR25 + 1x Kommander-KA02 I)	/







Fitness and Wellness Centers

# GYMS

## Configuration 2

120 sq m / 1291 sq ft

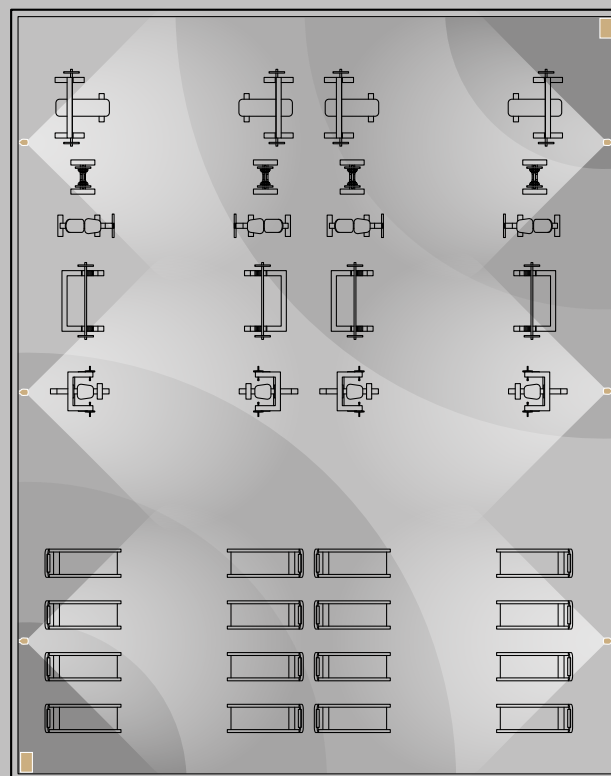
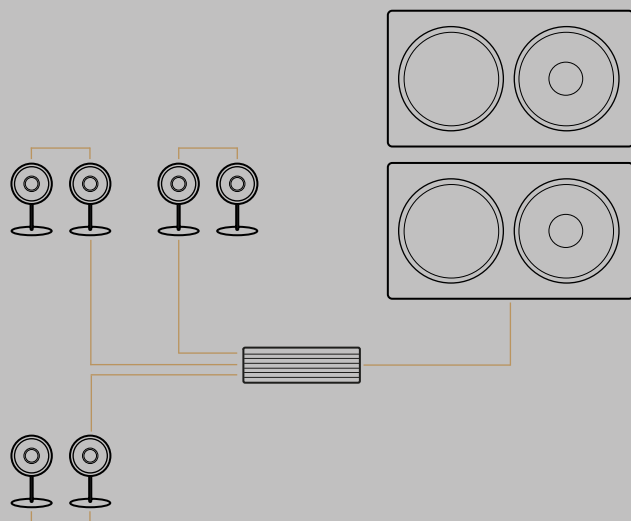

**Tornado-KT2**

Speaker  
40 x 1000 x 22 mm  
1,8 kg



**Rumble-KU26**

Subwoofer  
500 x 282 x 151 mm  
11 kg



**Kommander-KA04 I**

Amplifier  
430 x 87 x 430 mm  
6 kg



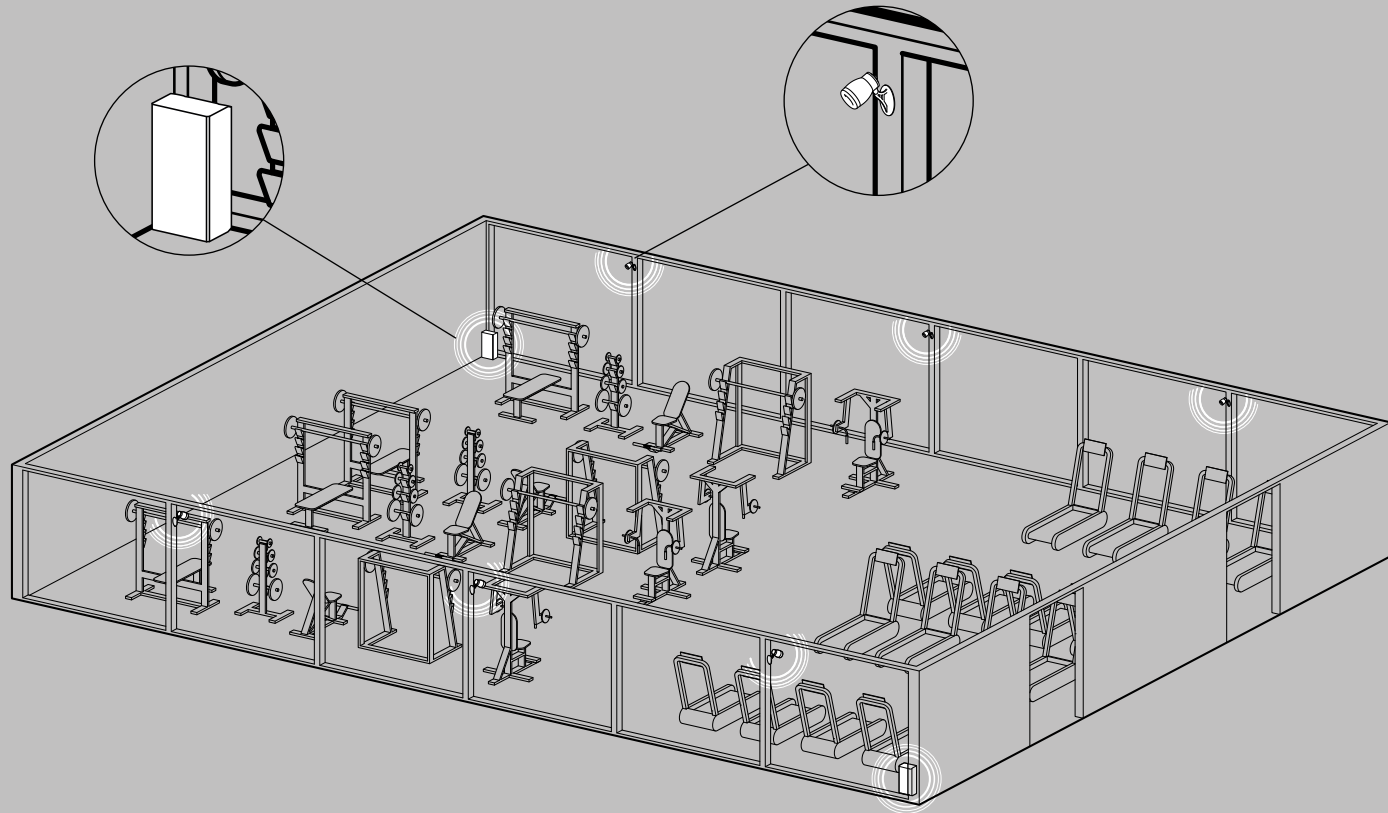

## Configuration 2

120 sq m / 1219 sq ft

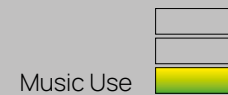

Conf.	Area	Speakers	Subwoofers	Amplifiers	Accessories
1	60 sq m (645 sq ft)	4x <b>Tornado-KT2</b>	1x <b>Rumble-KU26</b>	1x <b>Kommander-KA04</b>	1x <b>K-WF26</b> (OPT.)
2	120 sq m (1291 sq ft)	6x <b>Tornado-KT2</b>	2x <b>Rumble-KU26</b>	1x <b>Kommander-KA04</b>	1x <b>K-WF26</b> (OPT.)
3	180 sq m (1937 sq ft)	8x <b>Tornado-KT2</b>	4x <b>Rumble-KU26</b>	1x <b>Kommander-KA04</b>	1x <b>K-WF26</b> (OPT.)



Fitness and Wellness Centers

# FITNESS STUDIOS

## Configuration

120 sq m / 1291 sq ft

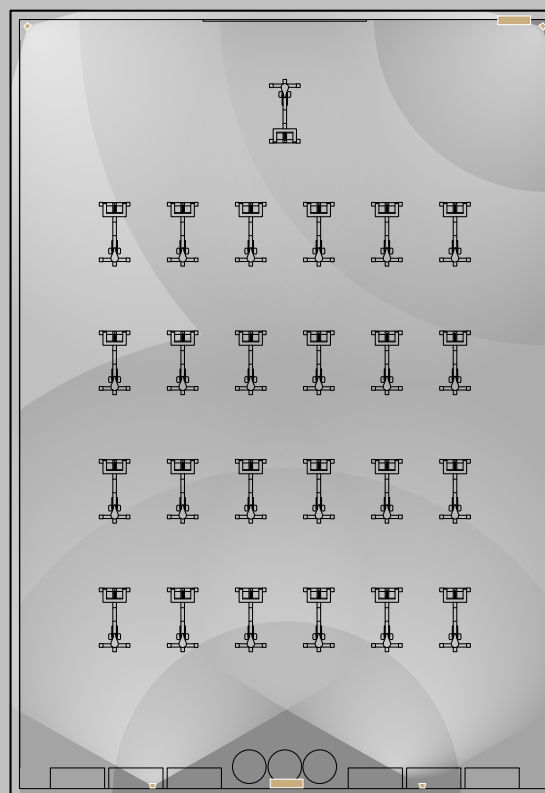
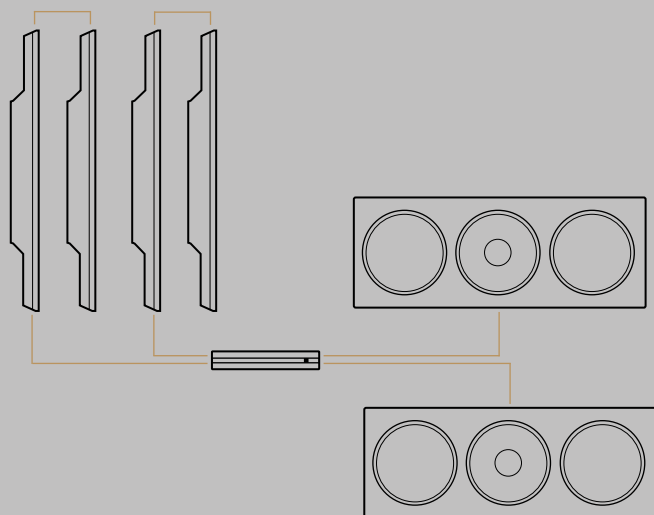

**Kobra-KK102 I**

Speaker  
40 x 1000 x 22 mm  
1,8 kg

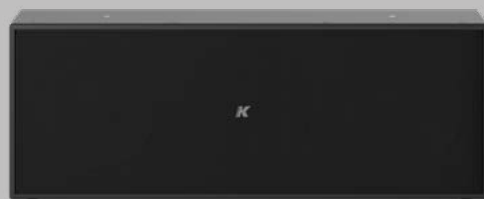

**Rumble-KU315**

Subwoofer  
500 x 282 x 151 mm  
11 kg



**Kommander-KA34**

Amplifier  
430 x 87 x 430 mm  
6 kg



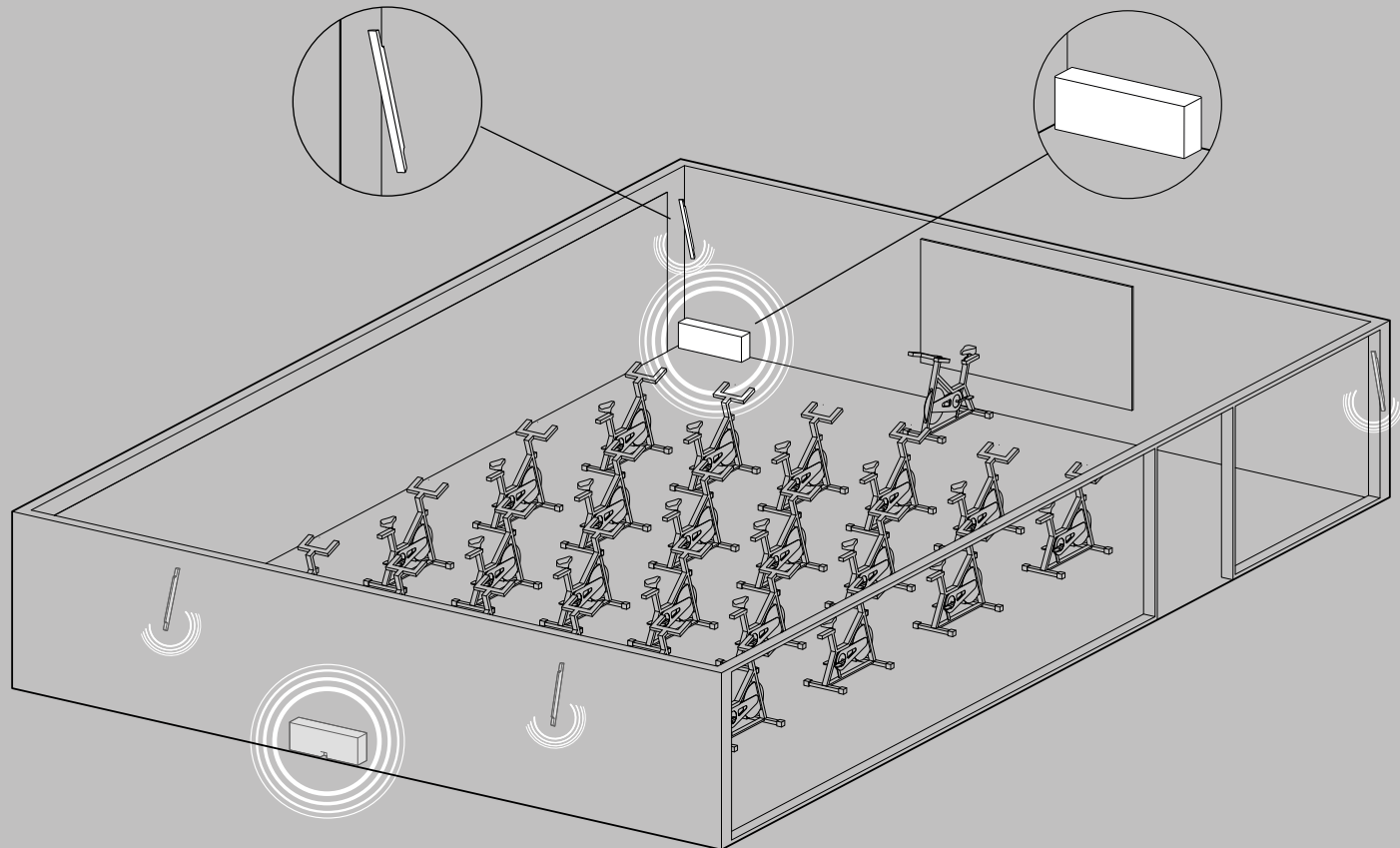

## Configuration

120 sq m / 1291 sq ft

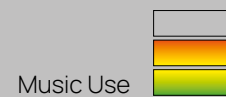

Conf.	Area	Speakers	Subwoofers	Amplifiers	Accessories
1	60 sq m (645 sq ft)	4x <b>Kobra-KK52 I</b>	2x <b>Rumble-KU210</b>	1x <b>Kommander-KA14 I</b>	1x <b>K-WF210</b> (OPT.) 4x <b>K-WALL2L</b>
2	120 sq m (1291 sq ft)	4x <b>Kobra-KK102 I</b>	2x <b>Rumble-KU315</b>	1x <b>Kommander-KA34</b>	4x <b>K-WALL2L</b>
3	180 sq m (1937 sq ft)	4x <b>Pyton-KP102 I</b>	4x <b>Rumble-KU315</b>	1x <b>Kommander-KA208</b>	4x <b>K-WALL2L</b>



## Cruise Ships

The challenging atmosphere of cruise ships require durable audio systems. K-ARRAY's weather-resistant, marine-grade loudspeakers have anti-corrosion treatments for outdoor areas while ensuring high sound quality.

Safety is ensured with reliable communication via distributed audio systems for clear public addresses and emergency notifications.









Cruise Ships

# SHIP DECKS

Configuration 1

600 sq m / 6358 sq ft

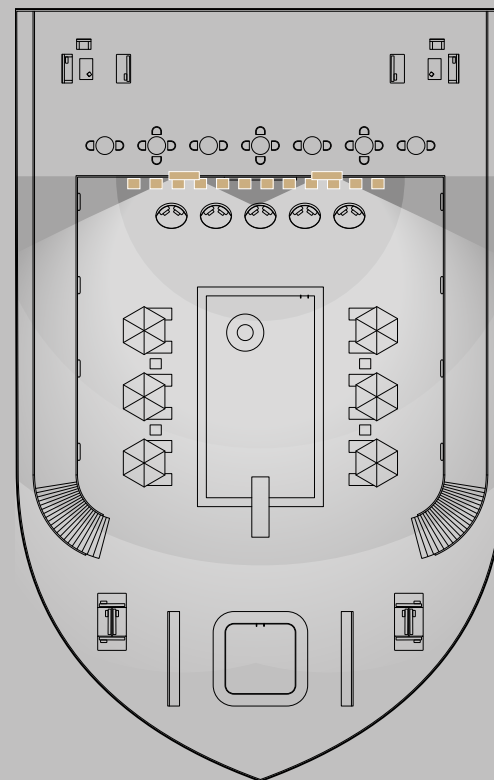
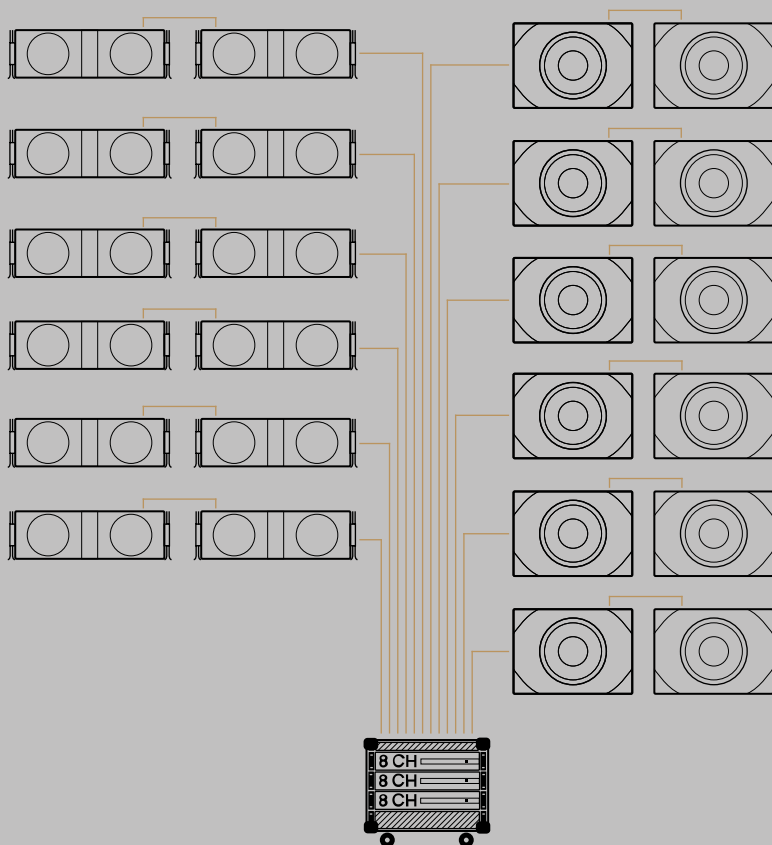

**Mugello-KH2MP I**

Speaker  
40 x 1000 x 22 mm  
1,8 kg



**Thunder-KS3MP I**

Subwoofer  
500 x 282 x 151 mm  
11 kg



**K-RACK-M-208**

Amplifier  
430 x 87 x 430 mm  
6 kg



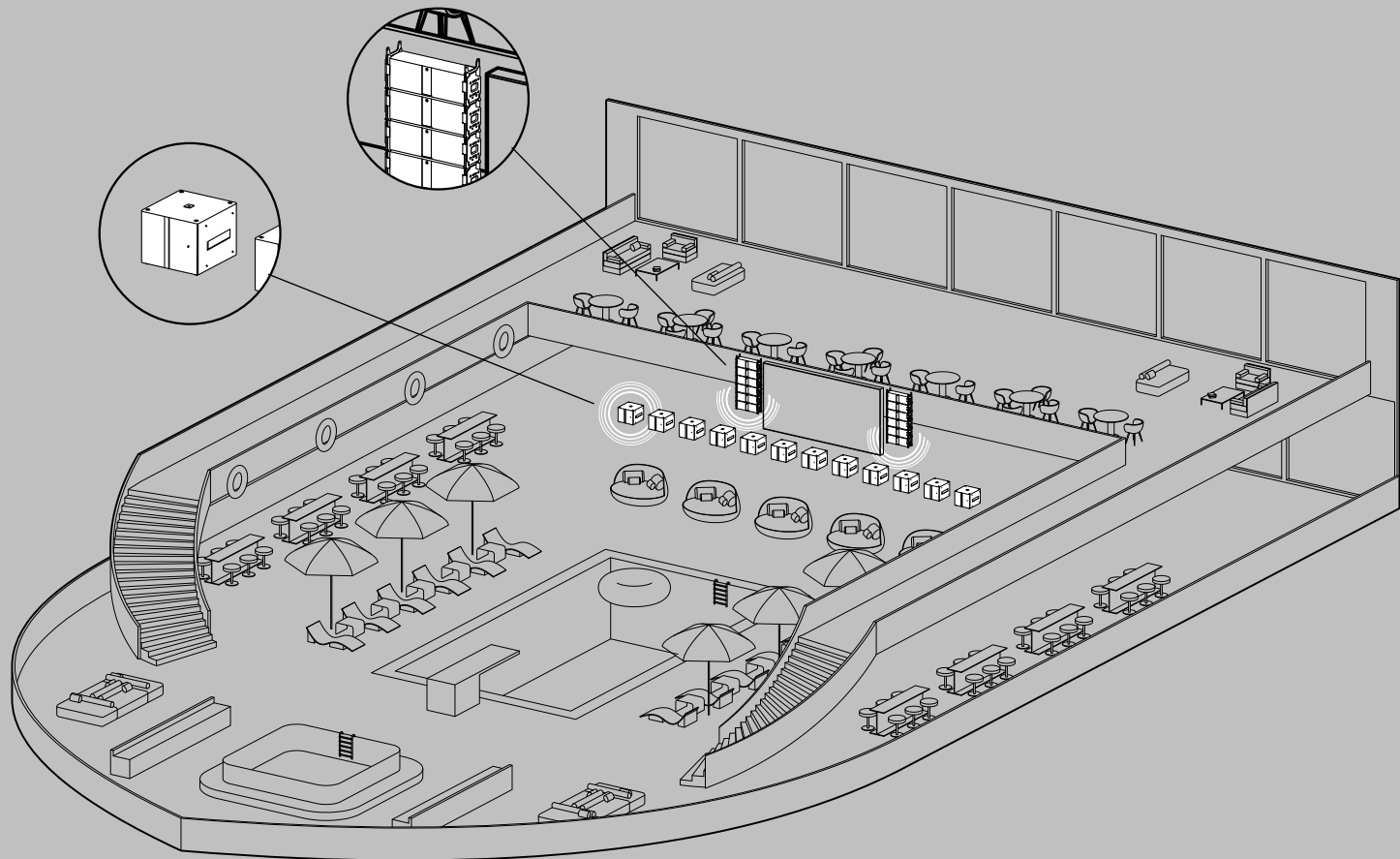

### Configuration 1

600 sq m / 6458 sq ft

Music Use 

Conf.	Area	Speakers	Subwoofers	Amplifiers	Accessories
1	600 sq m (6458sq ft)	12x <b>Mugello-KH2MP I</b> (Marine)	12x <b>Thunder-KS3MP I</b> (Marine)	1x <b>K-RACK-M-208</b>	

## HOSPITALITY & LEISURE

AUDIO SOLUTIONS



# Casinos

K-ARRAY's advanced audio solutions provide precise sound coverage for the diverse requirements of a casino. Pure Array Technology creates distinct audio zones, allowing a transition from lively gaming areas to quieter dining spaces, and ensures exceptional sound quality in entertainment spaces.



## GAMING HALLS





Casinos

# LUXURY GAMING HALL

Configuration 2

300 sq m / 3229 sq ft

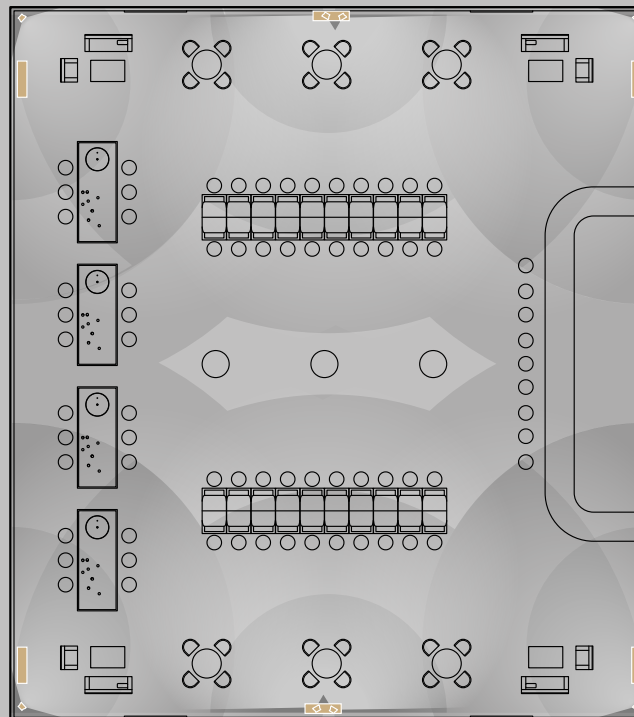
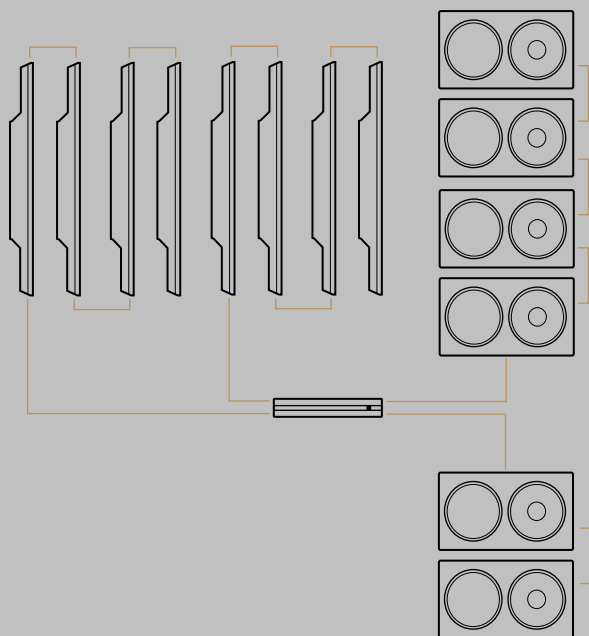

**Kobra-KK102 I**

Speaker  
40 x 1000 x 22 mm  
1,8 kg

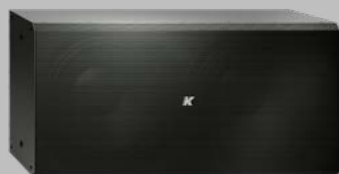

**Rumble-KU212**

Subwoofer  
500 x 282 x 151 mm  
11 kg



**Kommander-KA104 I**

Amplifier  
430 x 87 x 430 mm  
6 kg



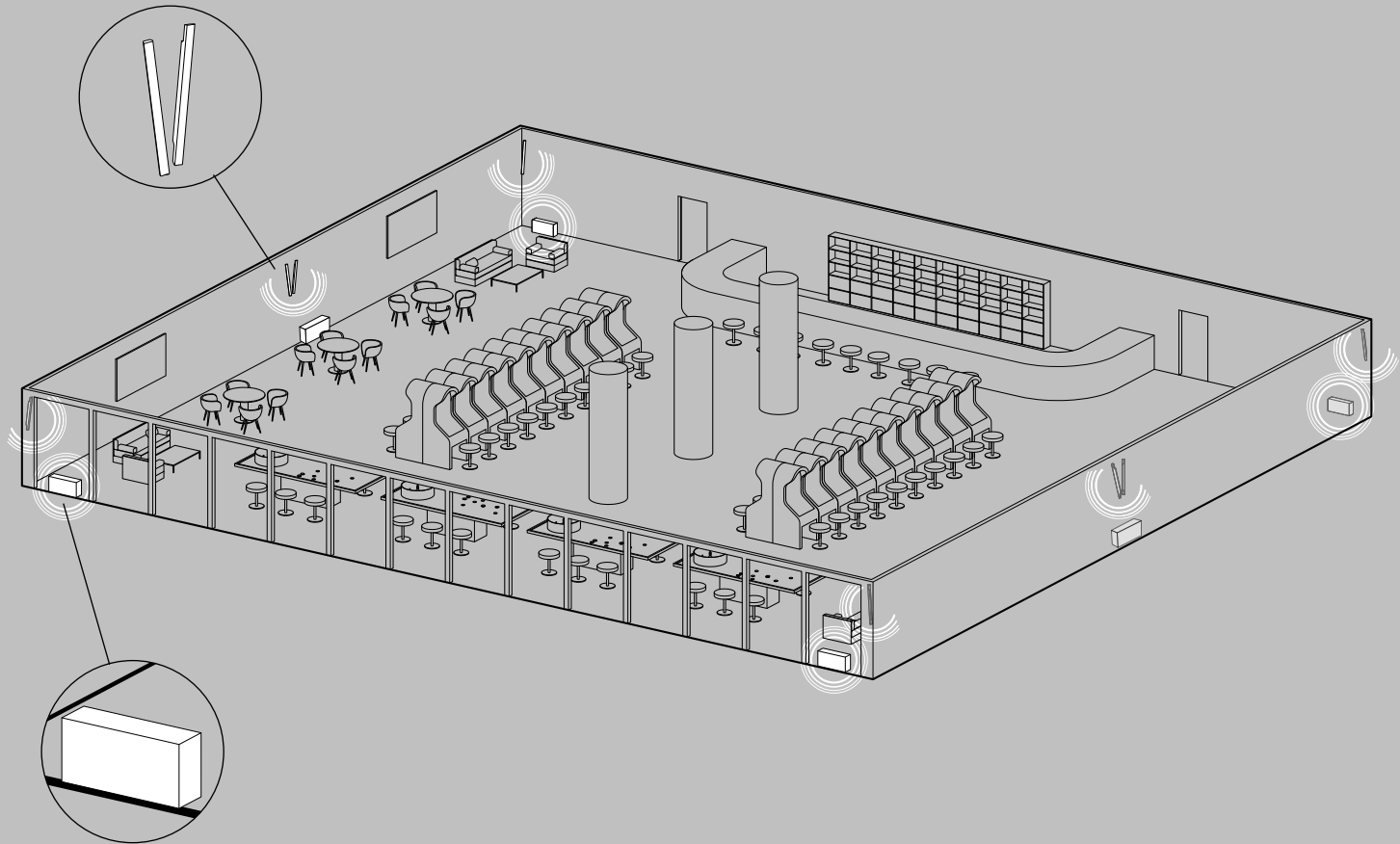

## Configuration 2

300 sq m / 3229 sq ft

Music Use



Conf.	Area	Speakers	Subwoofers	Amplifiers	Accessories
1	150 sq m (1614 sq ft)	4x <b>Kobra-KK102 I</b>	4x <b>Rumble-KU212</b>	1x <b>Kommander-KA104</b>	4x <b>K-WALL2</b>
2	300 sq m (3229 sq ft)	8x <b>Kobra-KK102 I</b>	6x <b>Rumble-KU212</b>	1x <b>Kommander-KA104</b>	8x <b>K-WALL2</b>



## HOSPITALITY & LEISURE

AUDIO SOLUTIONS



# Nightclubs & Lounges

Step into a realm where sonic artistry meets immersive energy. K-ARRAY systems power nightclubs by weaving a tapestry of booming bass lines, crisp highs, and a perfectly-balanced mid-range. Designed for those who seek unparalleled sound clarity and depth, K-ARRAY ensures that every beat penetrates the soul. As the night unfolds, let K-ARRAY's superior sound encapsulate every moment, fostering unforgettable memories on the dance floor.

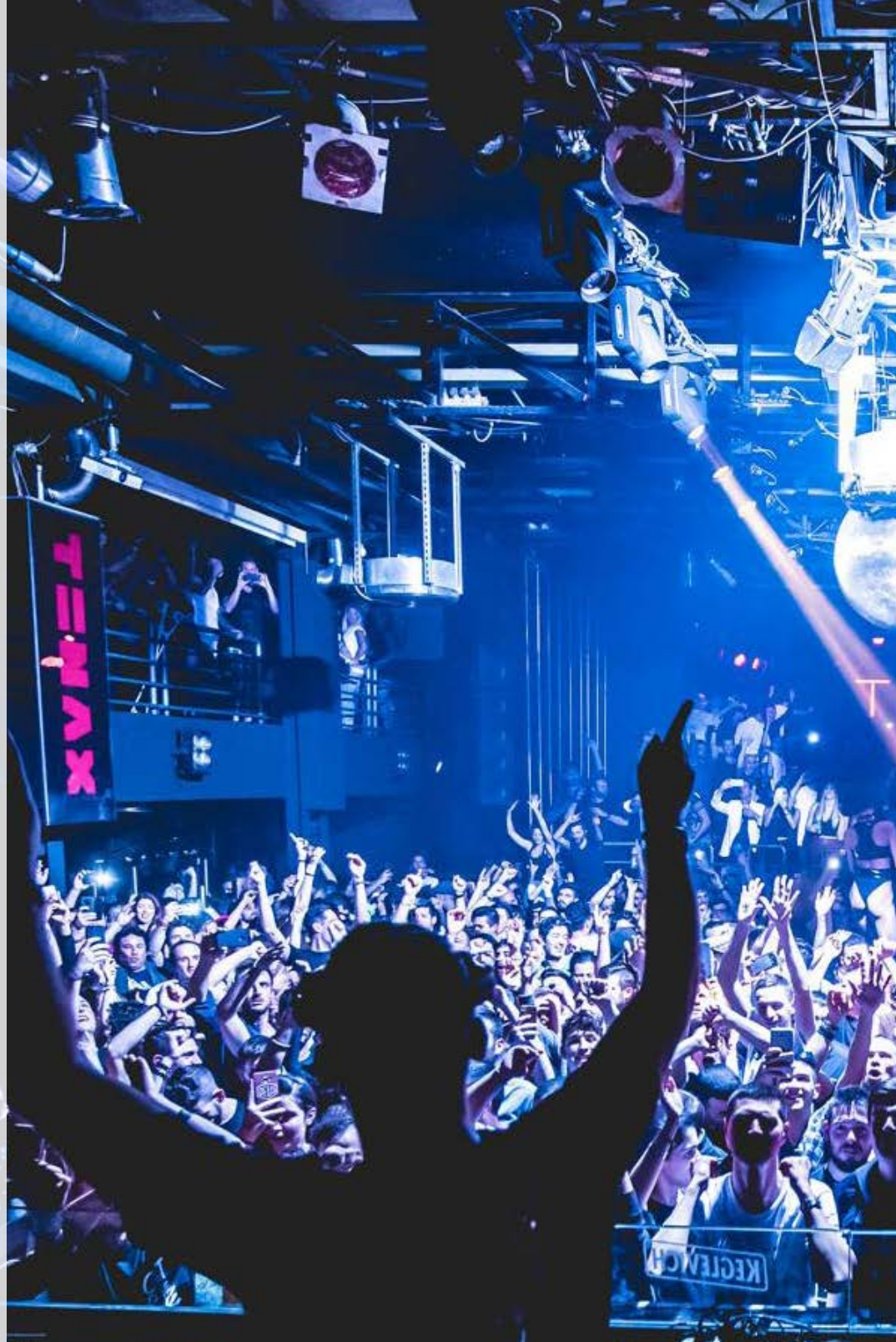

## NIGHTCLUBS







Nightclubs & Lounges

# DANCE FLOOR AREAS

Configuration 3

400 sq m / 4305sq ft

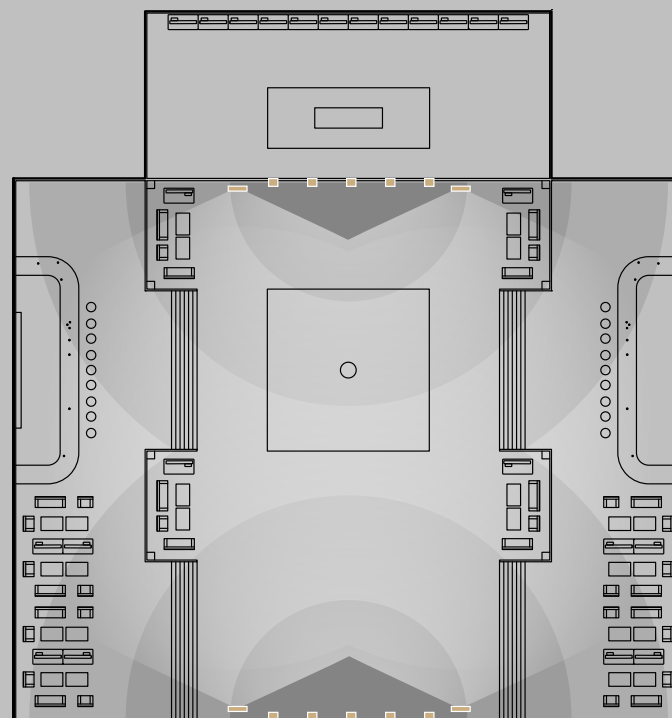
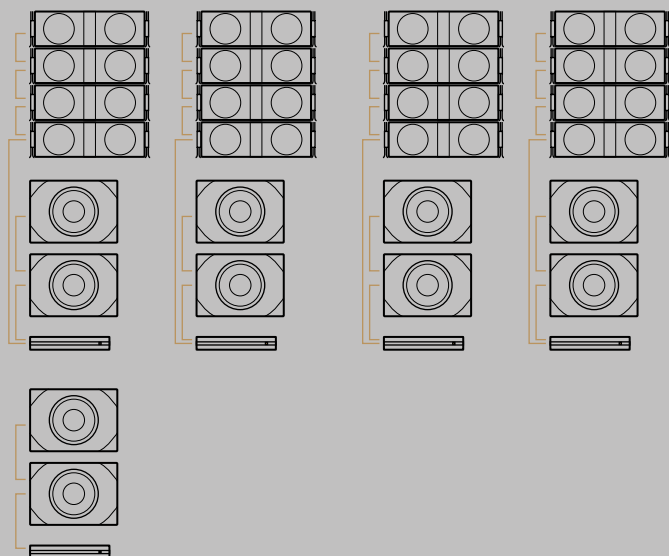

**Mugello-KH2MP I**

Speaker  
40 x 1000 x 22 mm  
1,8 kg



**Thunder-KS3MP I**

Subwoofer  
500 x 282 x 151 mm  
11 kg



**Kommander-KA208**

Amplifier  
430 x 87 x 430 mm  
6 kg



**Kommander-KA104**

Amplifier  
430 x 87 x 430 mm  
6 kg



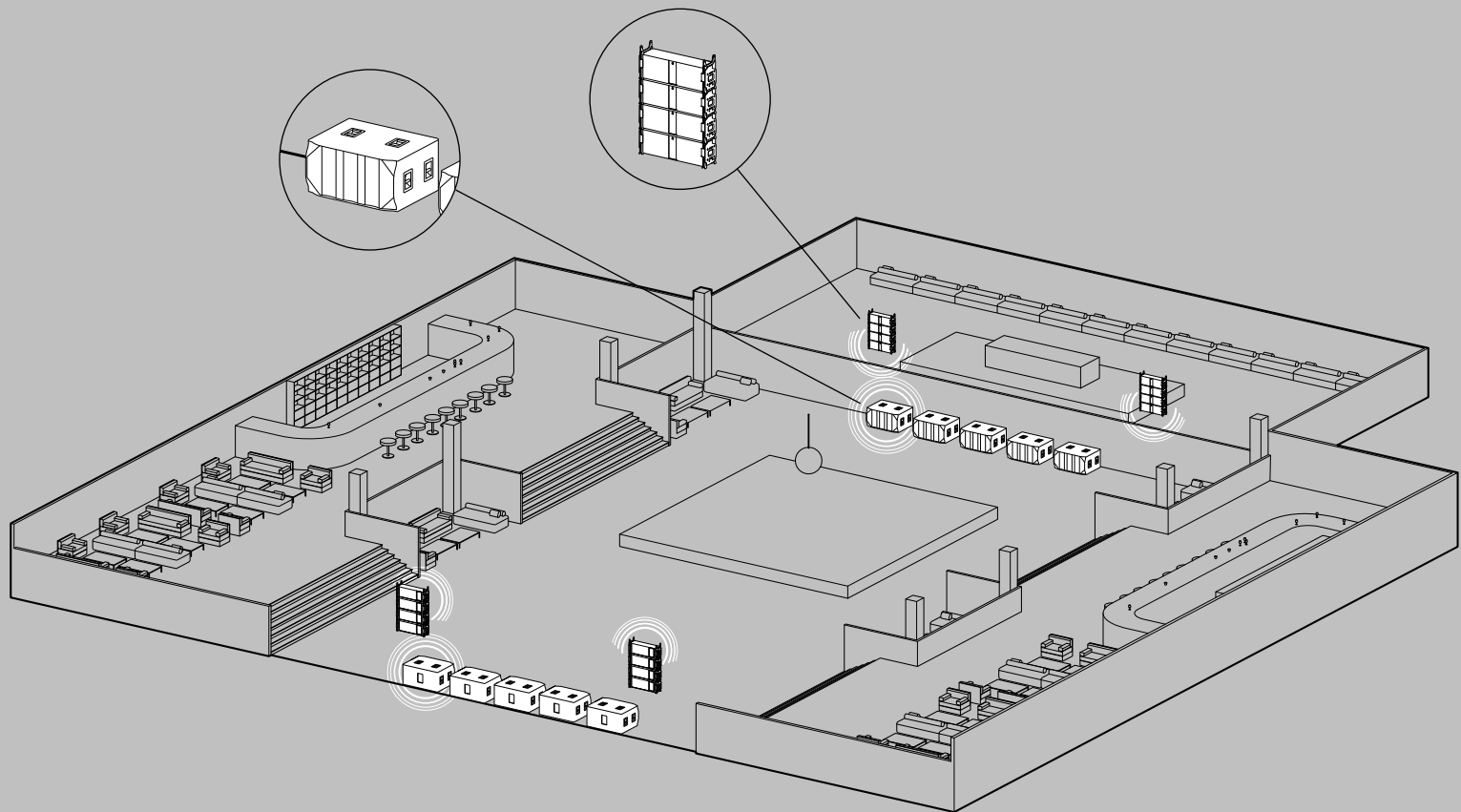

**Configuration 3**  
400 sq m / 4305 sq ft

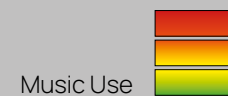

Conf.	Area	Speakers	Subwoofers	Amplifiers	Accessories
1	100sq m (1076 sq ft)	4x <b>Dragon-KX12</b>	4x <b>Thunder-KS3P I</b>	1x <b>Kommander-KA208</b>	4x <b>K-WALL2</b>
2	250 sq m (2690 sq ft)	12x <b>Dragon-KX12</b>	12x <b>Thunder-KS3P I</b>	2x <b>Kommander-KA208</b> 1x <b>Kommander-KA104</b>	12x <b>K-WALL2</b>
3	400 sq m (4305 sq ft)	16x <b>Mugello-KH2P I</b>	10x <b>Thunder-KS5P I</b>	4x <b>Kommander-KA208</b> 1x <b>Kommander-KA104</b>	4x <b>K-HCFLY2 I</b>





Nightclubs & Lounges

# PRIVÉ- VIP AREAS

Configuration 3

120 sq m / 1291 sq ft

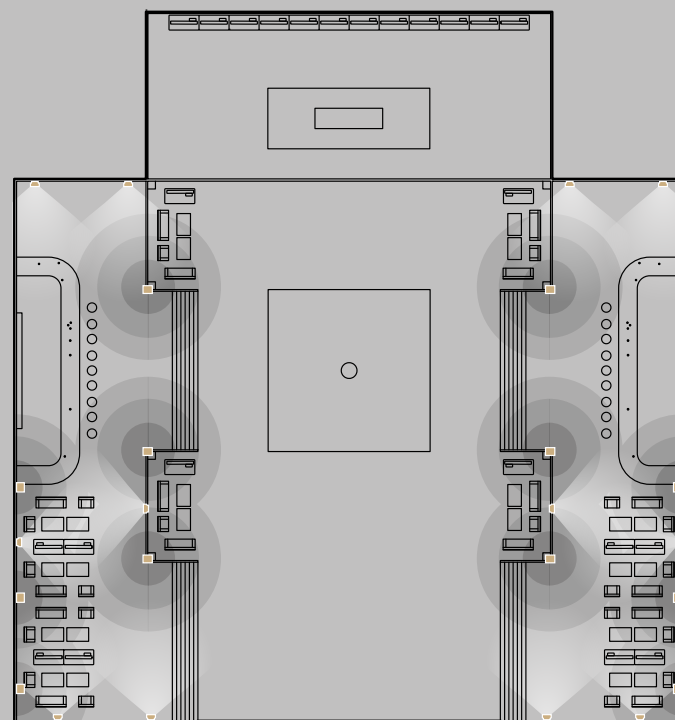
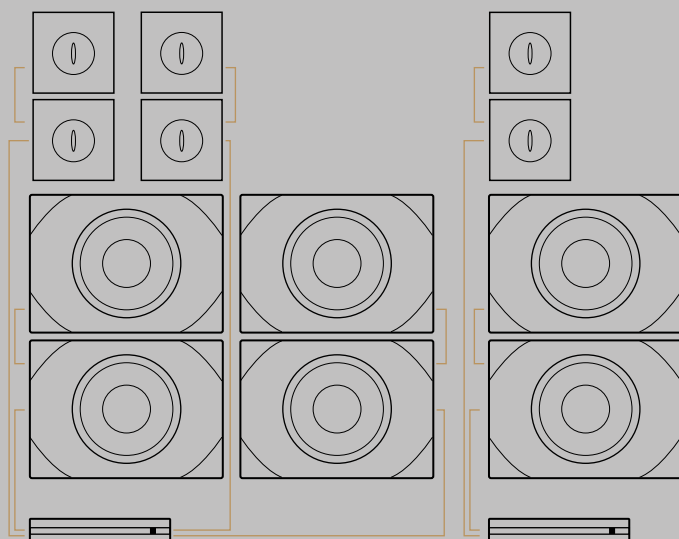

The product configuration shown below represents only one of the two private VIP areas featured in the image.



### **Dragon-KX12**

Speaker  
40 x 1000 x 22 mm  
1,8 kg



### **Thunder-KS3MP I**

Subwoofer  
500 x 282 x 151 mm  
11 kg



### **Kommander-KA208**

Amplifier  
430 x 87 x 430 mm  
6 kg



### **Kommander-KA104**

Amplifier  
430 x 87 x 430 mm  
6 kg



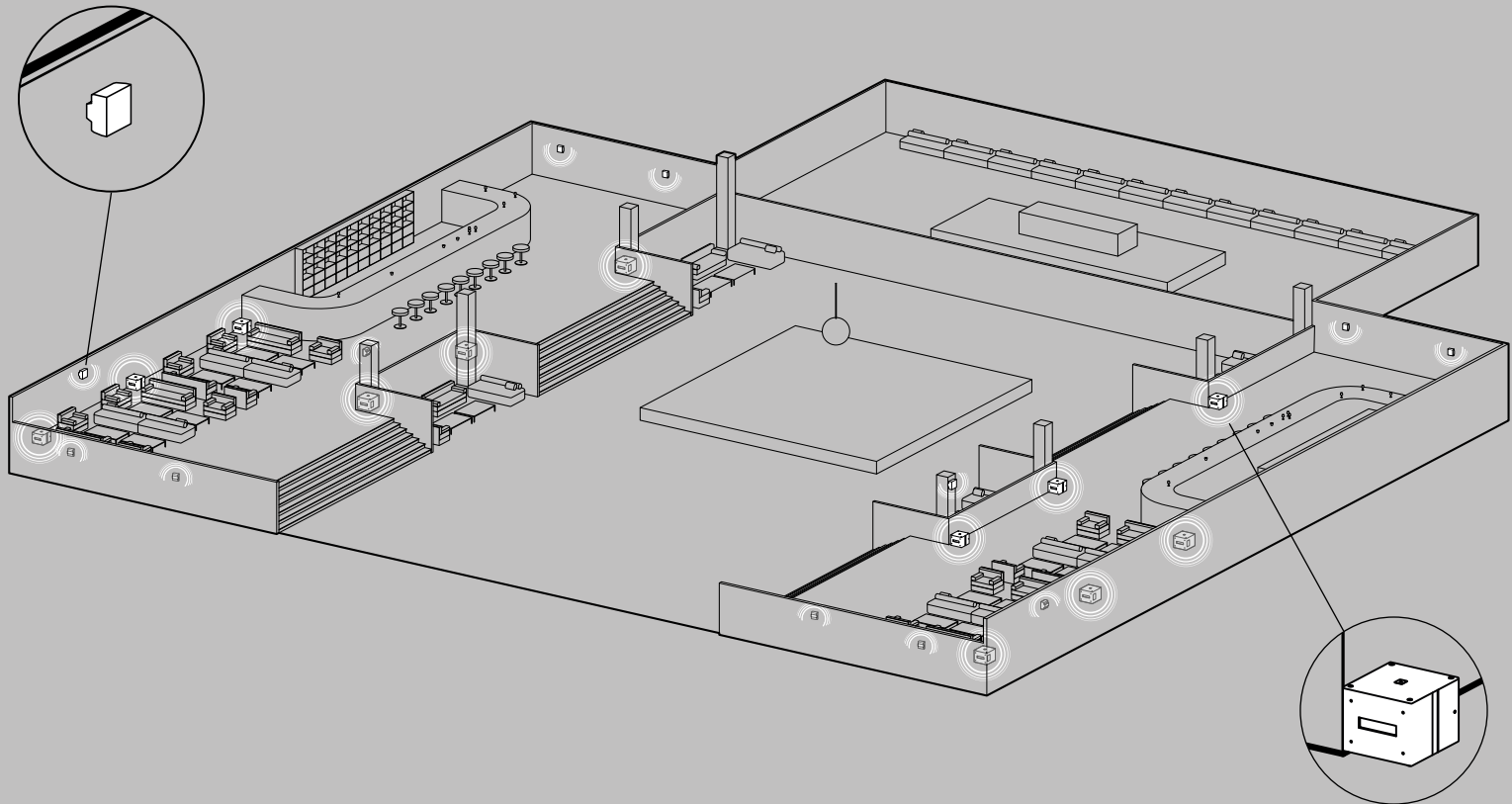

### Configuration 3

120 sq m / 1291 sq ft

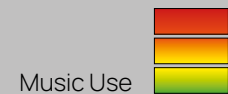

Conf.	Area	Speakers	Subwoofers	Amplifiers	Accessories
1	60 sq m (645 sq ft)	4x <b>Kayman-KY52</b>	4x <b>Rumble-KU315</b>	1x <b>Kommander-KA208</b>	4x <b>K-WALL2</b>
2	80 sq m (861 sq ft)	4x <b>Kayman-KY102</b>	4x <b>Thunder-KS3P I</b>	1x <b>Kommander-KA208</b>	4x <b>K-WALL2</b>
3	120 sq m (1291 sq ft)	6x <b>Dragon-KX12</b>	6x <b>Thunder-KS3P I</b>	1x <b>Kommander-KA208</b> 1x <b>Kommander-KA104</b>	6x <b>K-WALL2</b>



Nightclubs & Lounges

# DJ MONITORING SYSTEM

Configuration 3

Large

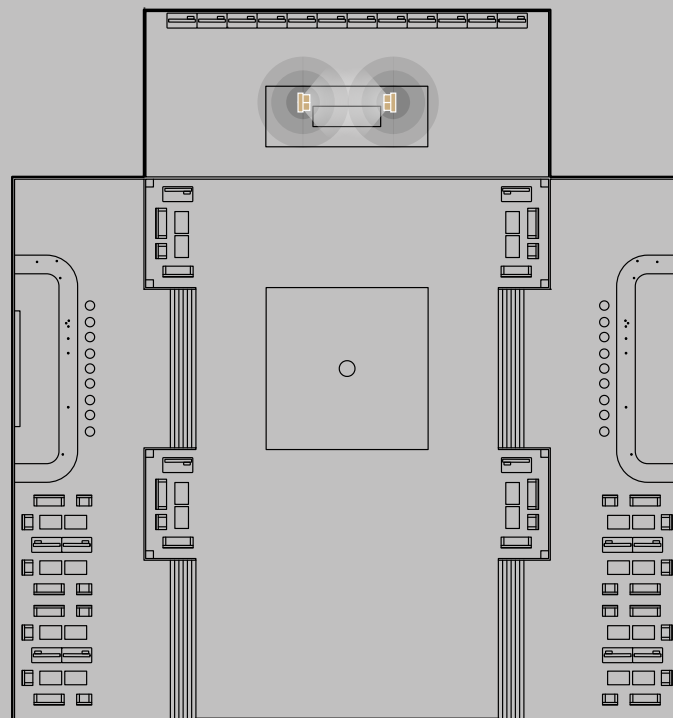
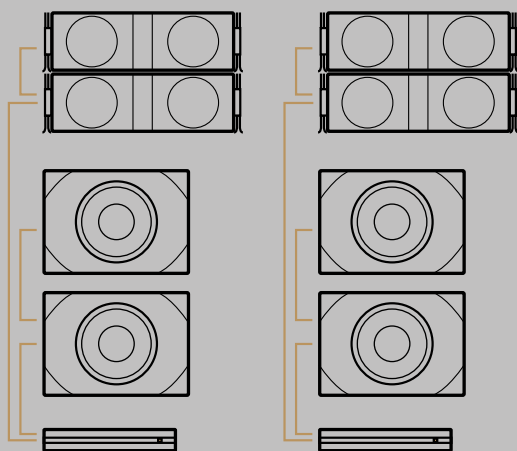

**Mugello-KH2MP I**

Speaker  
40 x 1000 x 22 mm  
1,8 kg



**Thunder-KS3MP I**

Subwoofer  
500 x 282 x 151 mm  
11 kg



**Kommander-KA208**

Amplifier  
430 x 87 x 430 mm  
6 kg



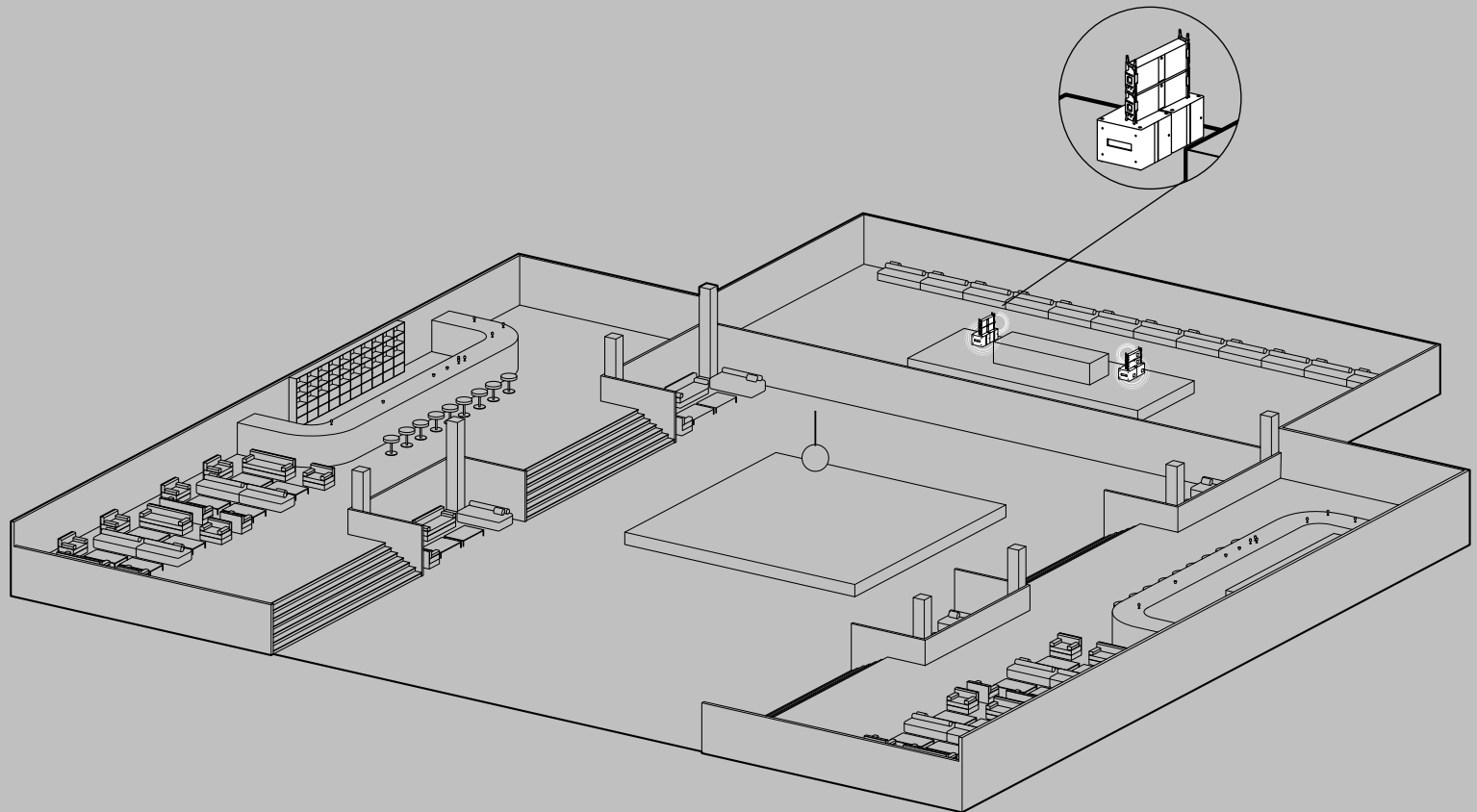

### Configuration 3

#### Large

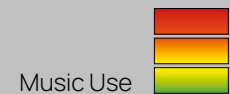

Conf.	Area	Speakers	Subwoofers	Amplifiers	Accessories
1	MID	4x <b>Dragon-KY52</b>	4x <b>Thunder-KS3P I</b>	1x <b>Kommander-KA208</b>	4x <b>K-JOINT2B</b> 2x <b>FLY22</b> 2x <b>PIVOT</b>
2	LARGE	4x <b>Mugello-KH2</b>	4x <b>Thunder-KS3P I</b>	2x <b>Kommander-KA208</b>	4x <b>K-EXTRFRAME</b>
3	X-LARGE	6x <b>Mugello-KH2</b>	2x <b>Thunder-KS7P I</b>	3x <b>Kommander-KA208</b>	2x <b>KHCBASE2</b>



## LOUNGES







Nightclubs & Lounges

# POOL/BEACH CLUBS

Configuration 2

300 sq m / 3229 sq ft

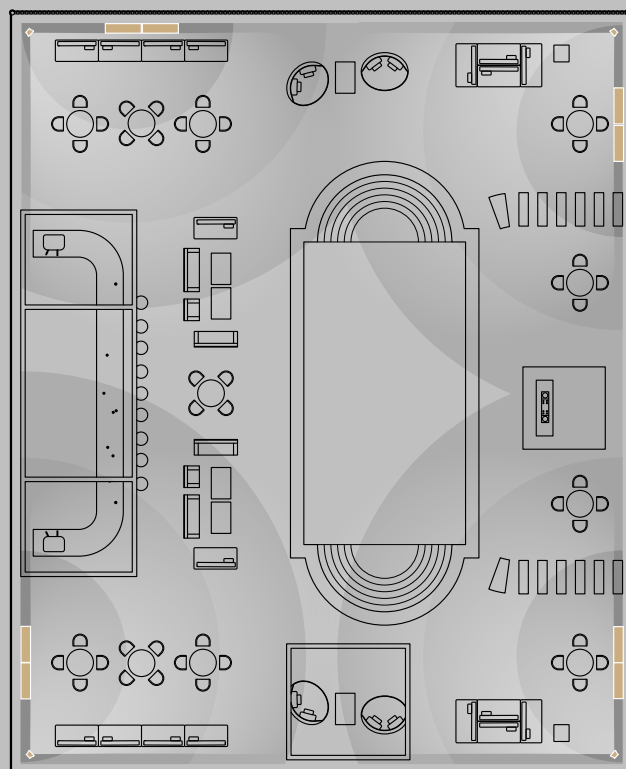
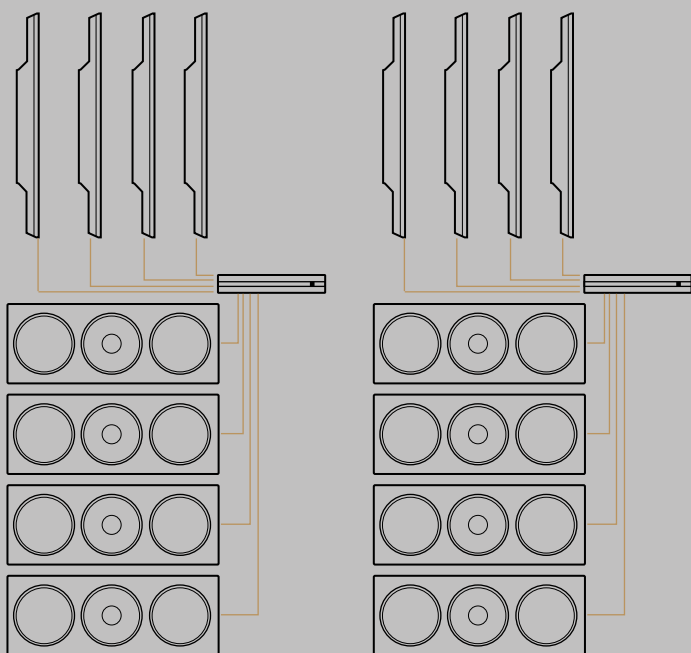

**Kayman-KY102M**

Speaker  
40 x 1000 x 22 mm  
1.8 kg

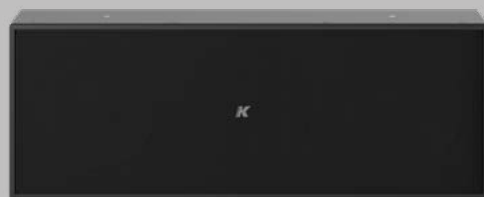

**Rumble-KU315**

Subwoofer  
500 x 282 x 151 mm  
11 kg



**Kommander-KA208 I**

Amplifier  
430 x 87 x 430 mm  
6 kg



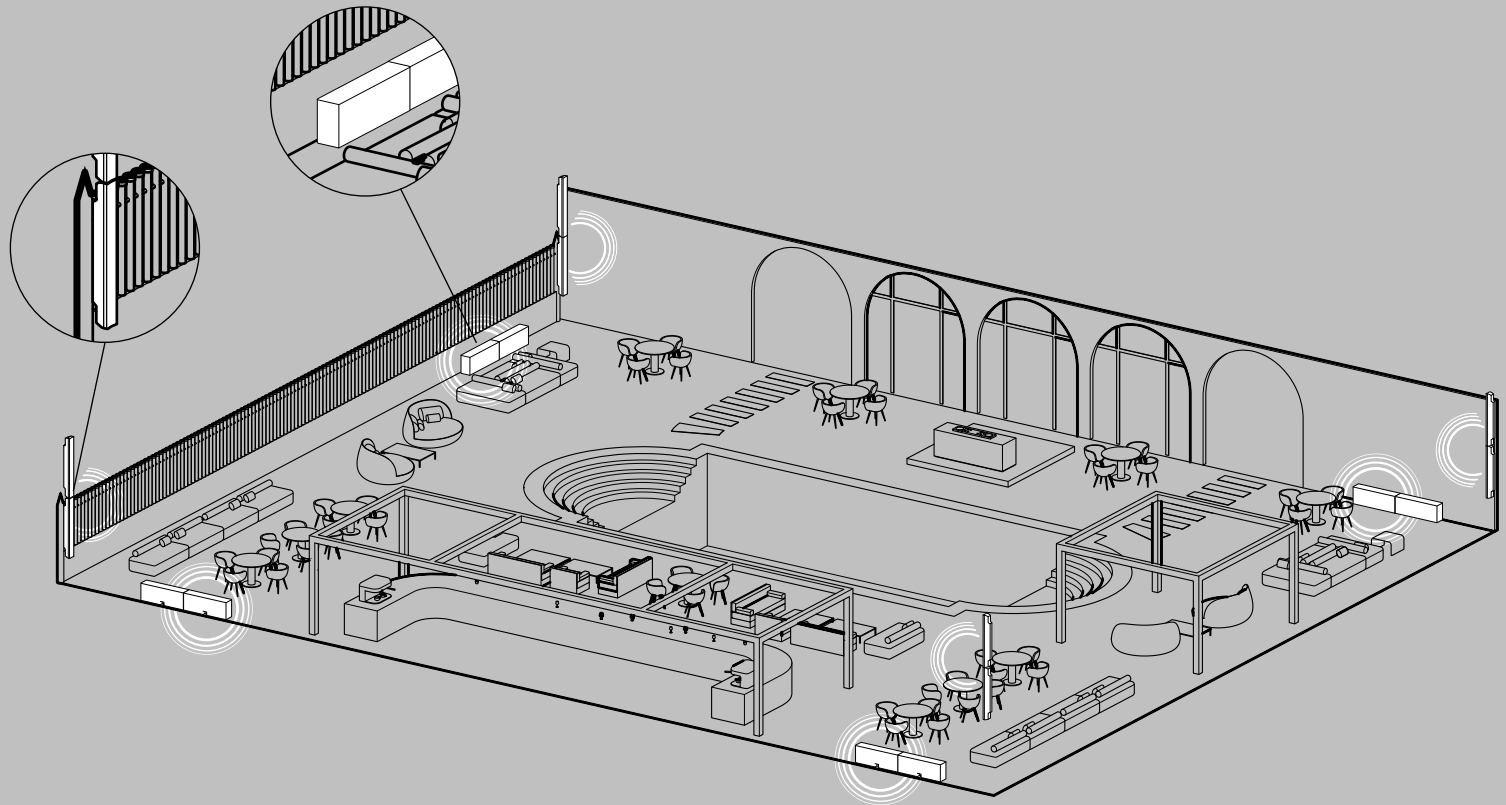

## Configuration 2

300 sq m / 3229 sq ft

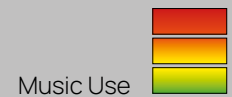

Conf.	Area	Speakers	Subwoofers	Amplifiers	Accessories
1	150 sq m (1614 sq ft)	4x <b>Kayman-KY102M</b>	4x <b>Rumble-KU315</b>	1x <b>Kommander-KA208</b>	4x <b>K-WALL2</b>
2	300 sq m (3229 sq ft)	8x <b>Kayman-KY102M</b>	8x <b>Rumble-KU315</b>	2x <b>Kommander-KA208</b>	8x <b>K-WALL2</b>
3	600 sq m (6458 sq ft)	16x <b>Mugello-KH2MP I</b>	16x <b>Thunder-KS3MP I</b>	4x <b>Kommander-KA208</b>	4x <b>K-HCFly2M I</b>



# **K**GEAR

Smart Audio Solutions



Hotel and Resort

P.

70



Restaurants and Cafes

74



Fitness & Wellness Centers

84



Casinos

90



Nightclubs & Lounges

94

## Consistent Quality Sound for Every Hospitality Setting

In expansive hotel and resort settings where cost-effective solutions without compromising sound quality are key, KGEAR stands out. These reliable sound configurations offer a blend of affordability and high-performance, seamlessly fitting into diverse hospitality decors, making them an excellent choice for establishments that prioritize both value and excellence in audio.



## Hotels and Resorts

In hotel and resort settings where budget sensitive solutions without compromising sound quality are key, KGEAR stands out.

These sound configurations offer the perfect balance between performance and value, seamlessly fitting into the most diverse hospitality decors.

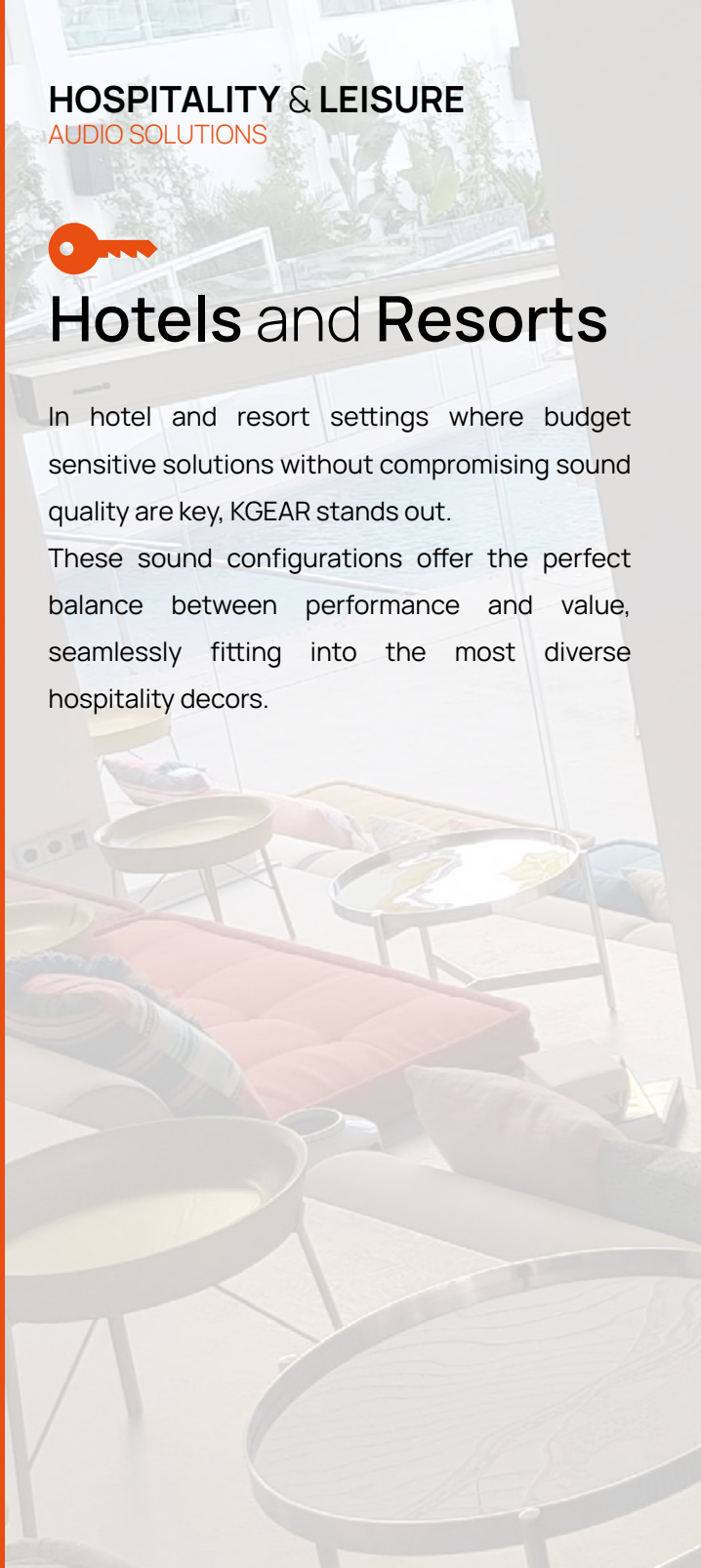





Hotels & Resorts

# LOBBIES & LOUNGES

Configuration 3

180 sq m / 1937 sq ft

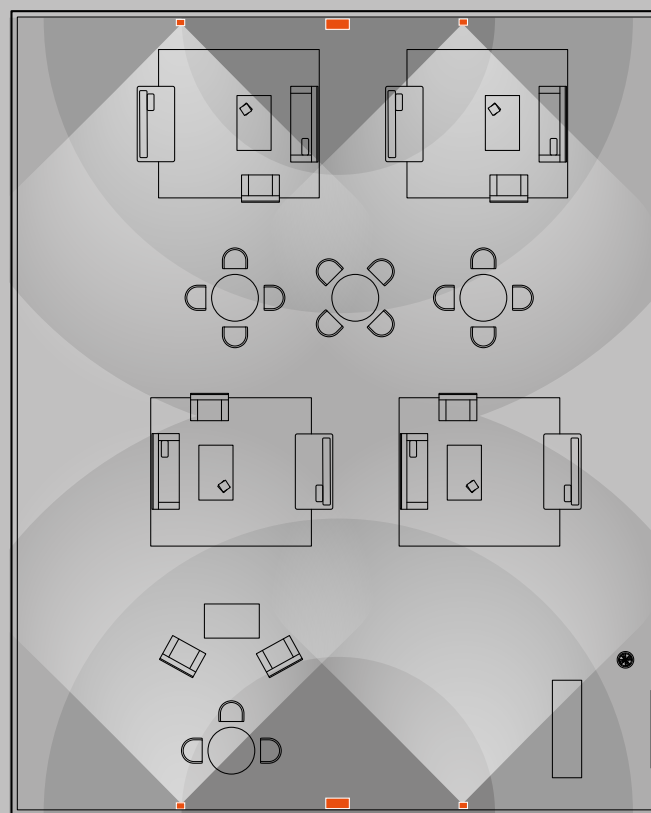
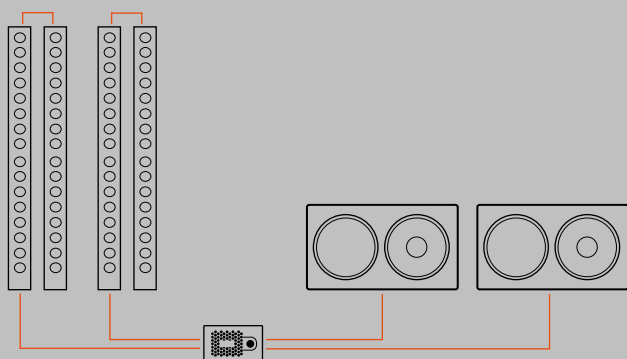

**GF162**

Speaker  
40 x 1000 x 22 mm  
1,8 kg



**GU210**

Subwoofer  
500 x 282 x 151 mm  
11 kg

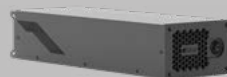

**GA43**

Amplifier  
430 x 87 x 430 mm  
6 kg





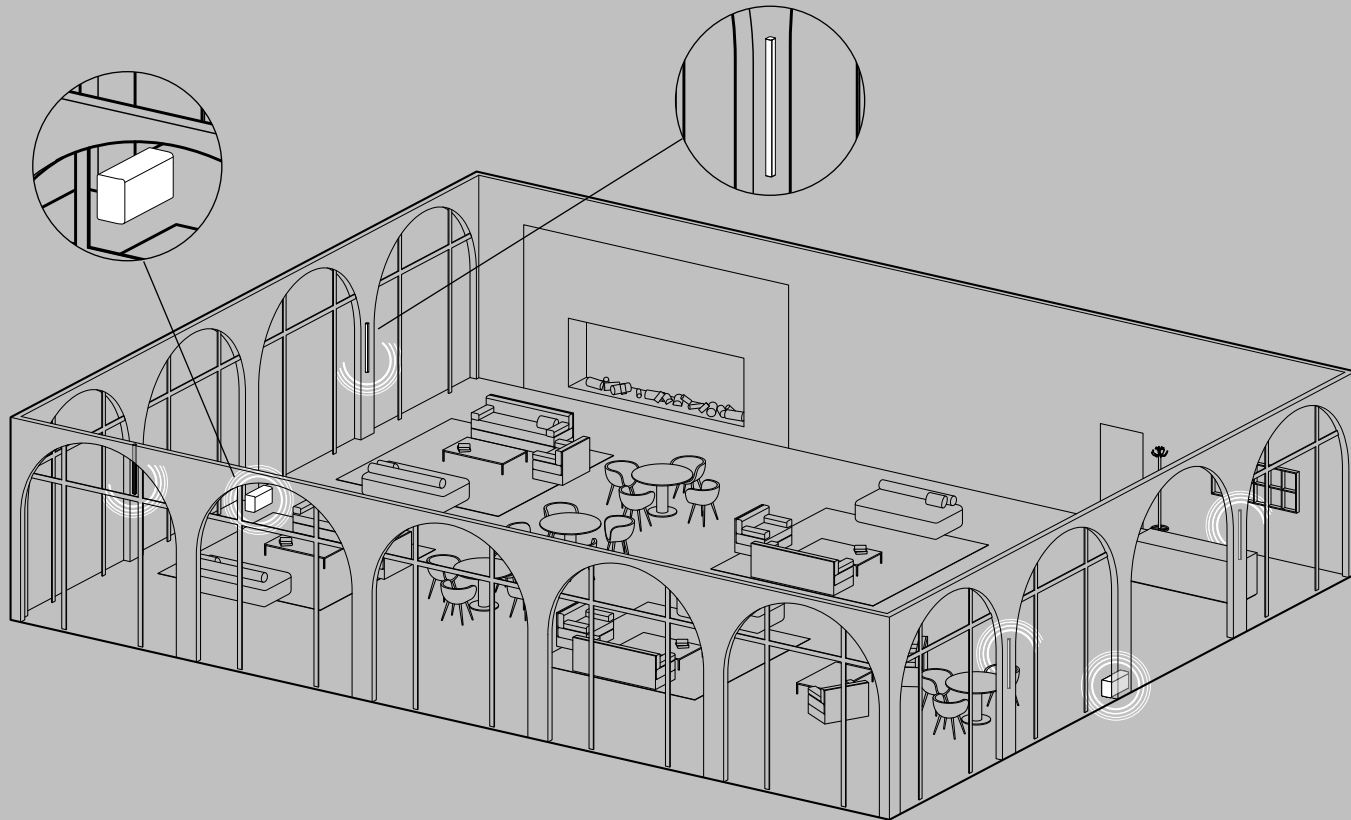

### Configuration 3

180 sq m / 1937 sq ft

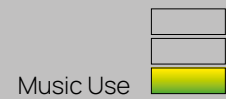

Conf.	Area	Speakers	Subwoofers	Amplifiers	Accessories
1	40 sq m (430 sq ft)	4x <b>GC3</b>	/	1x <b>GA201</b>	/
2	90 sq m (968 sq ft)	4x <b>GF42</b>	2x <b>GS6</b>	1x <b>GA201</b>	
3	180 sq m (1937 sq ft)	4x <b>GF162</b>	2x <b>GU210</b>	1x <b>GA43</b>	<b>G-RACK</b>

## HOSPITALITY & LEISURE

AUDIO SOLUTIONS



# Restaurants and Cafes

Create the perfect ambiance with KGEAR's background music systems, providing a pleasant dining experience for guests.

Utilize KGEAR's elegant speakers to seamlessly integrate into the decor, preserving aesthetics while delivering high-quality audio.

Address acoustic challenges and control sound levels with KGEAR's versatile speaker systems, ensuring a comfortable and enjoyable atmosphere for diners.



## RESTAURANTS





Restaurants & Cafes

# DINING ROOMS

## Configuration 2

90 sq m / 968 sq ft

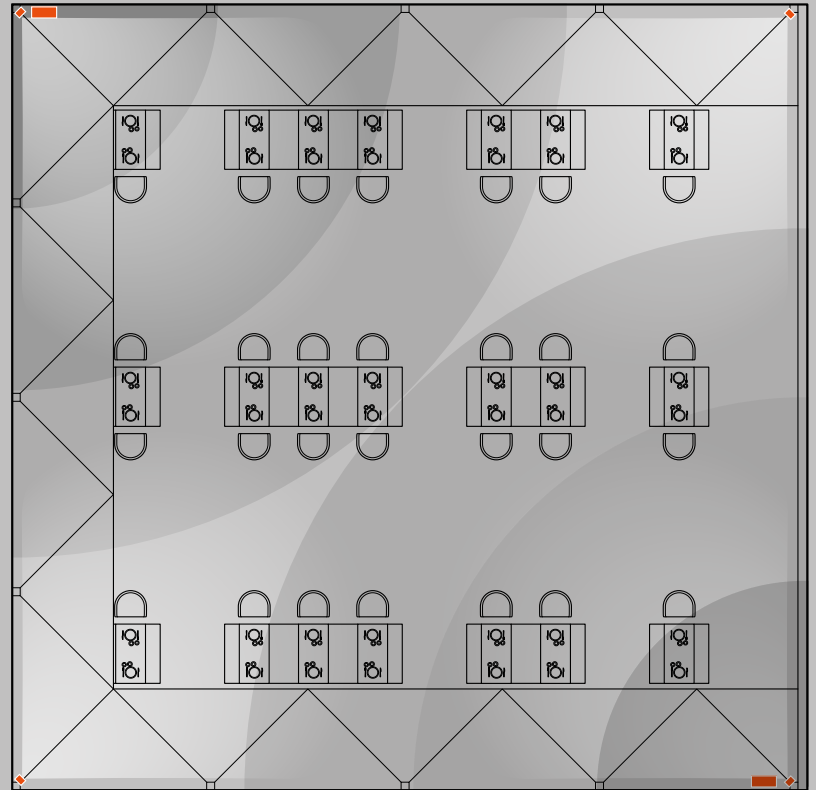
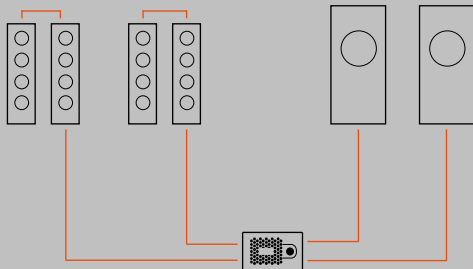

**GF42**

Speaker  
40 x 1000 x 22 mm  
1,8 kg



**GS6**

Subwoofer  
500 x 282 x 151 mm  
11 kg



**GA41**

Amplifier  
430 x 87 x 430 mm  
6 kg



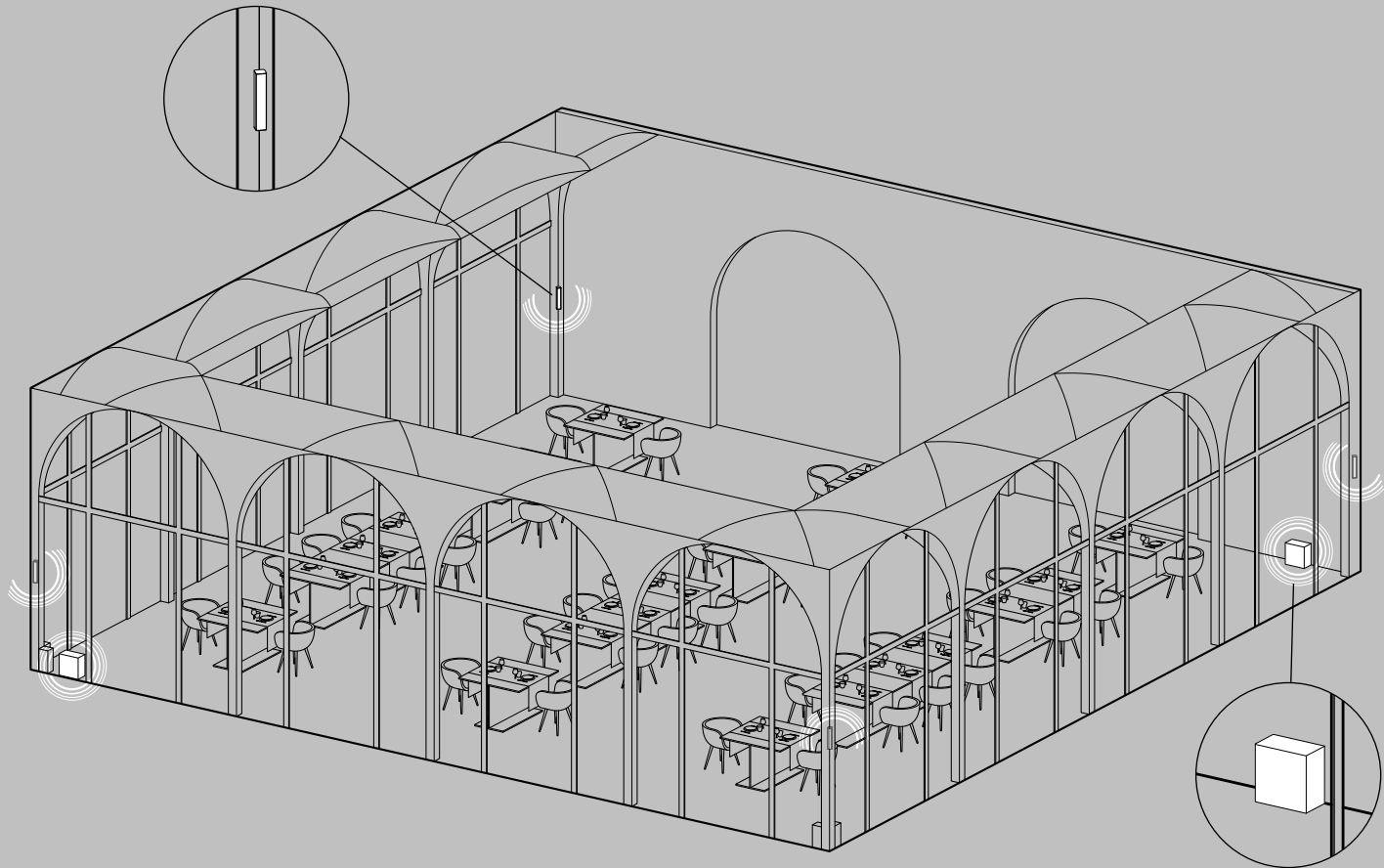

## Configuration 2

90 sq m / 968 sq ft

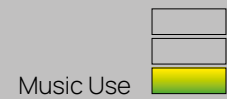

Conf.	Area	Speakers	Subwoofers	Amplifiers	Accessories
1	60 sq m (645 sq ft)	4x <b>GF22</b>	1x <b>GS6</b>	1x <b>GA201</b>	
2	90 sq m (968 sq ft)	4x <b>GF42</b>	2x <b>GS6</b>	1x <b>GA41</b>	
3	180 sq m (1937 sq ft)	4x <b>GF162</b>	2x <b>GU210</b>	1x <b>GA43</b>	G-RACK







Restaurants & Cafes

## CAFES

Configuration 2

60 sq m / 645 sq ft

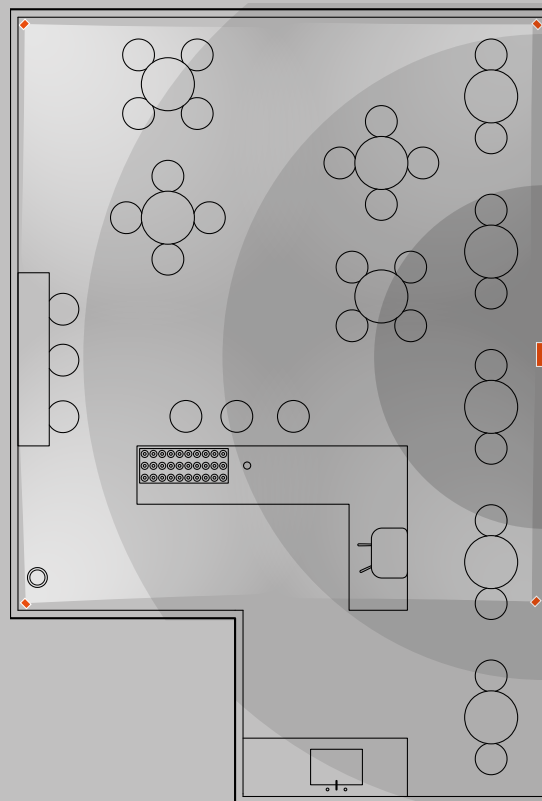
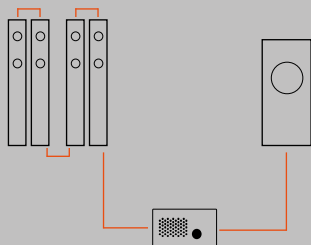

**GF22**

Speaker  
40 x 1000 x 22 mm  
1,8 kg



**GS6**

Subwoofer  
500 x 282 x 151 mm  
11 kg



**GA201**

Amplifier  
430 x 87 x 430 mm  
6 kg





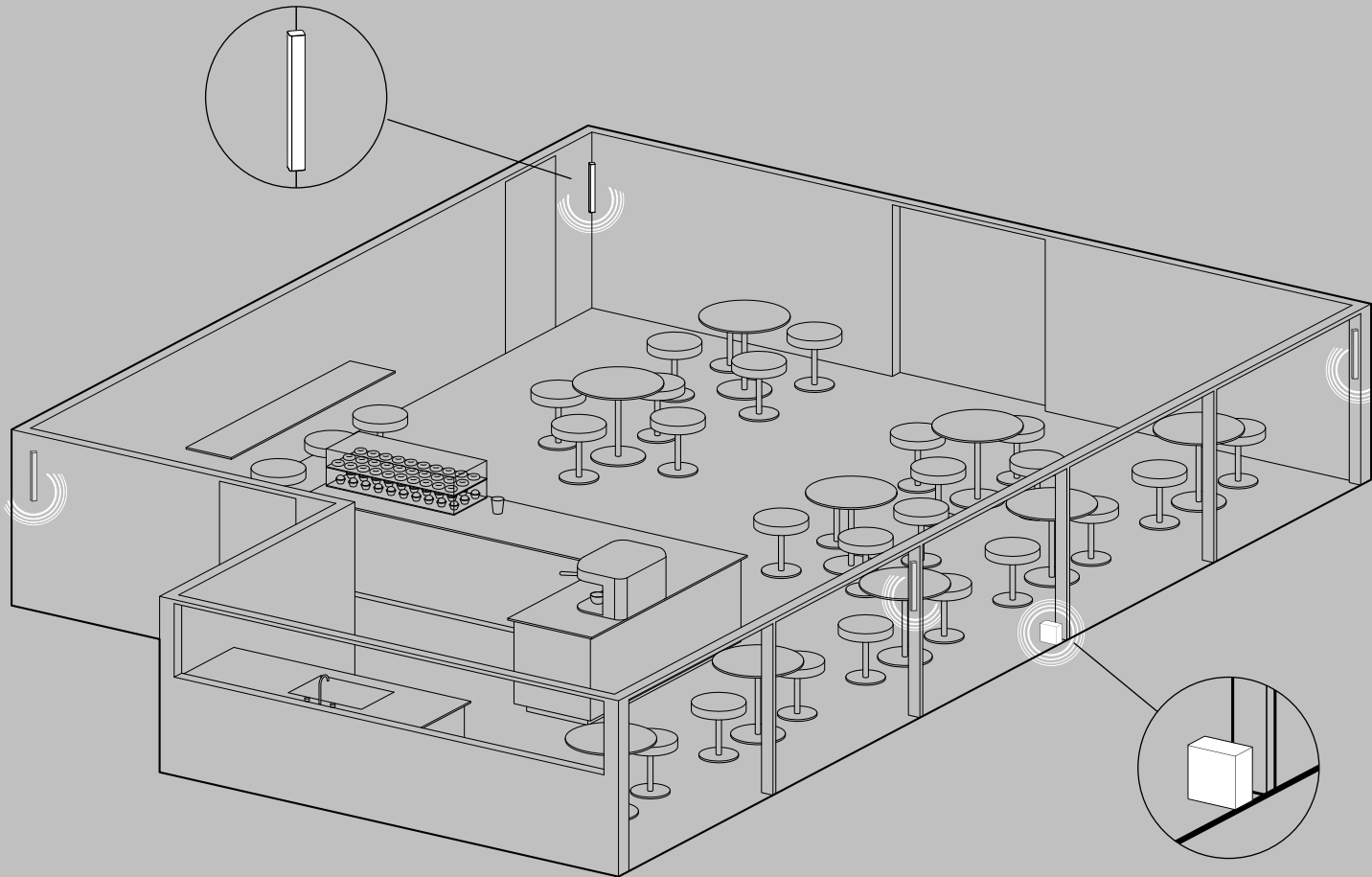

## Configuration 2

60 sq m / 645 sq ft

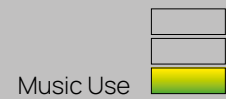

Conf.	Area	Speakers	Subwoofers	Amplifiers	Accessories
1	30 sq m (322 sq ft)	2x <b>GC6</b>	/	1x <b>GA201</b>	
2	60 sq m (645 sq ft)	4x <b>GF22</b>	1x <b>GS6</b>	1x <b>GA201</b>	
3	90 sq m (968 sq ft)	6x <b>GF22</b>	2x <b>GS6</b>	1x <b>GA201</b>	



Restaurants & Cafes

# BARS

Configuration 2

120 sq m / 1291 sq ft

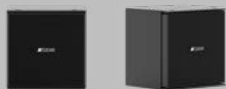
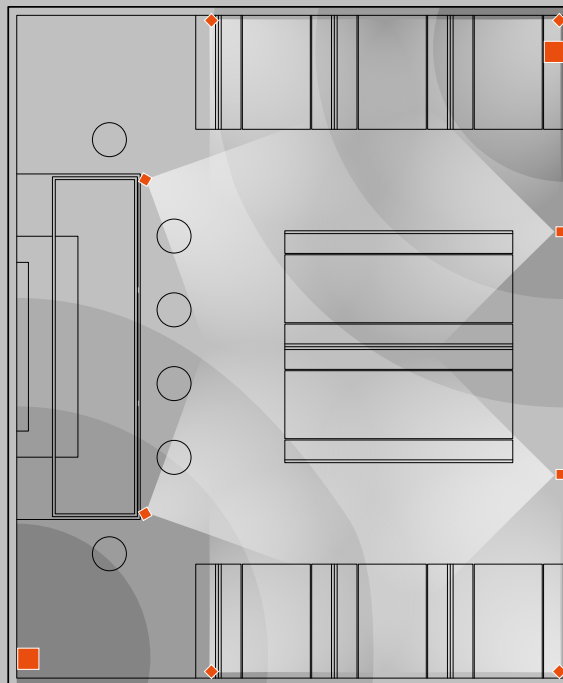
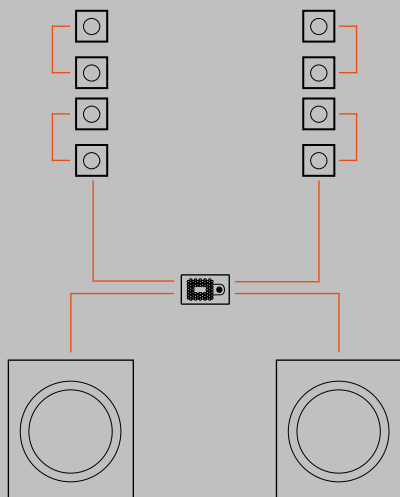

**GH4**

Speaker  
112x112x94 mm  
1,2 kg



**GS18**

Subwoofer  
545x610x600 mm  
34,4 kg

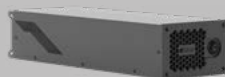

**GA46**

Amplifier  
145x90x418 mm  
3,8 kg



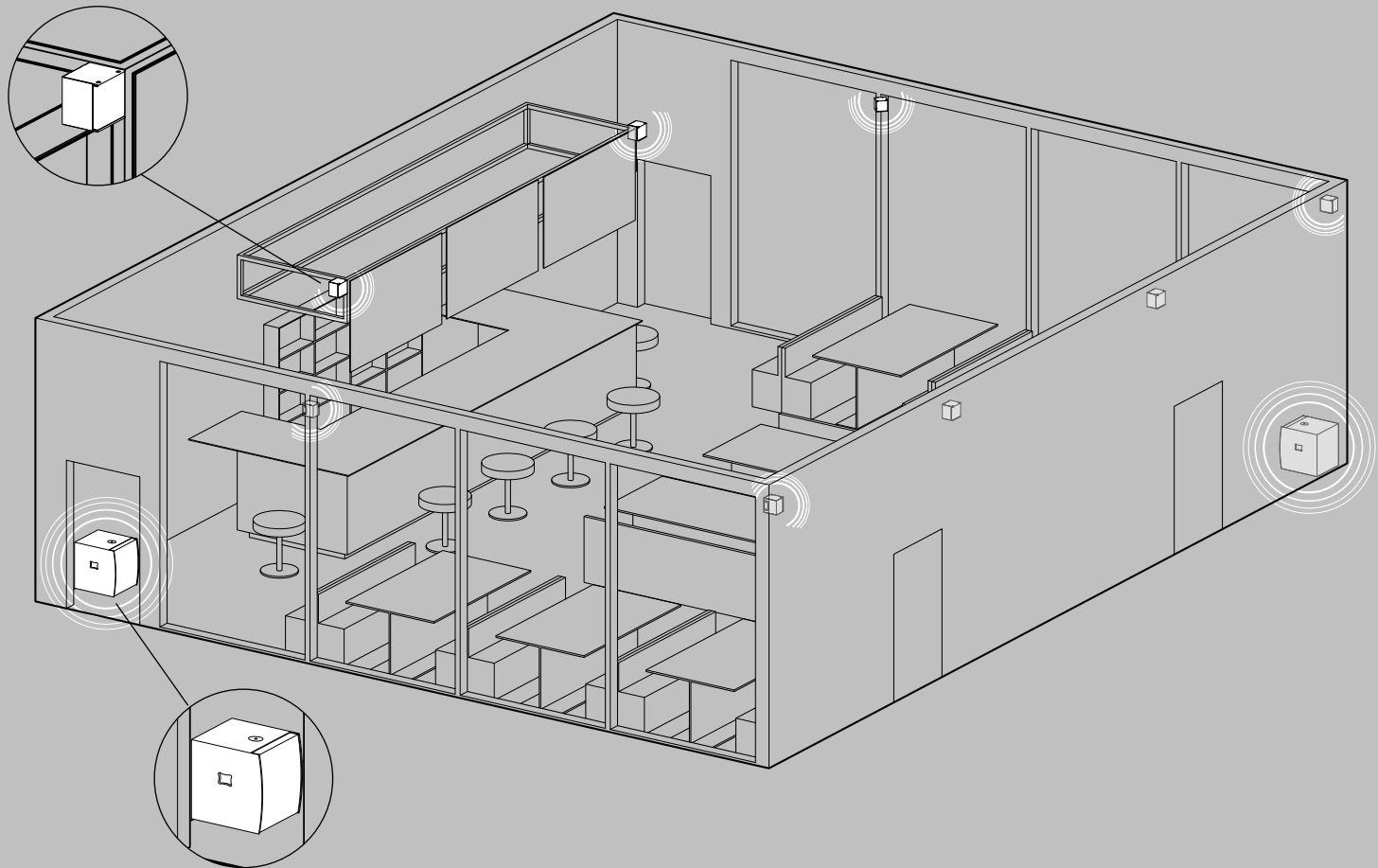

## Configuration 2

120 sq m / 1291 sq ft

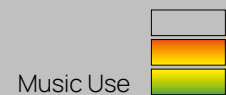

Conf.	Area	Speakers	Subwoofers	Amplifiers	Accessories
1	60 sq m (645 sq ft)	4x <b>GF82</b>	2x <b>GU210</b>	1x <b>GA43</b>	<b>G-RACK</b>
2	120 sq m (1291 sq ft)	8x <b>GH4</b>	2x <b>GS18</b>	1x <b>GA46</b>	<b>G-RACK</b>
3	180 sq m (1937 sq ft)	12x <b>GH4</b>	4x <b>GS28</b>	2x <b>GA46</b>	<b>G-RACK</b>

## HOSPITALITY & LEISURE

AUDIO SOLUTIONS



# Fitness and Wellness Centers

Equip group classes and workout areas with KGEAR's pro speaker systems, ensuring clear audio and speech intelligibility for instructors and participants.

Install unobtrusive in-ceiling speakers from the commercial audio line in relaxation and meditation areas, providing soothing background music and noise-masking while maintaining a budget-friendly approach.

Upgrade existing audio systems using KGEAR's efficient full-range speakers, offering an affordable solution that enhances audio performance without the need for extensive rewiring or infrastructure modifications.

Integrate KGEAR products designed for challenging environments, such as moist areas or locations near swimming pools and spas, providing durability and corrosion resistance at a competitive price.



## FITNESS





Fitness & Wellness

# GYMS

## Configuration 2

120 sq m / 1291 sq ft

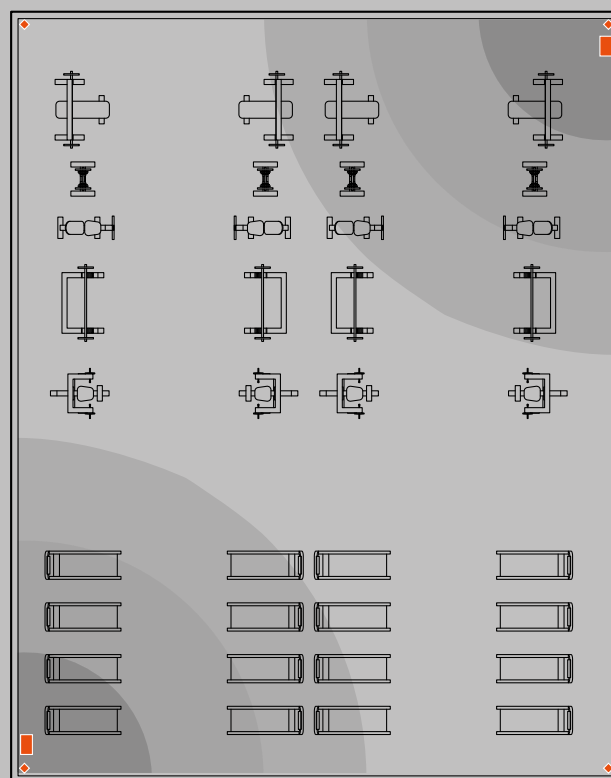
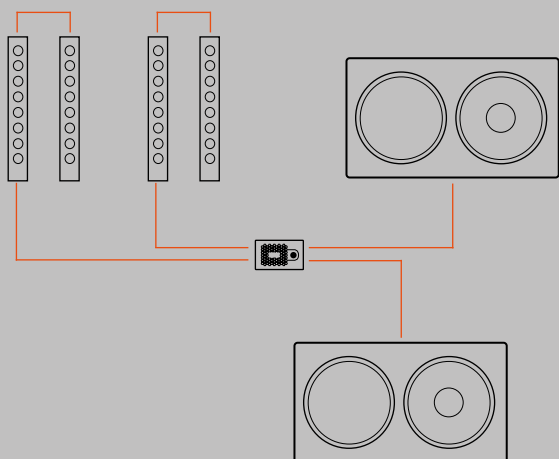

**GF82**

Speaker  
60 x 590 x 72 mm  
1,6 kg



**GU210**

Subwoofer  
556x200x116 mm  
7,9 kg

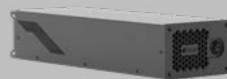

**GA41**

Amplifier  
145 x 90 x 418 mm  
2,6 kg



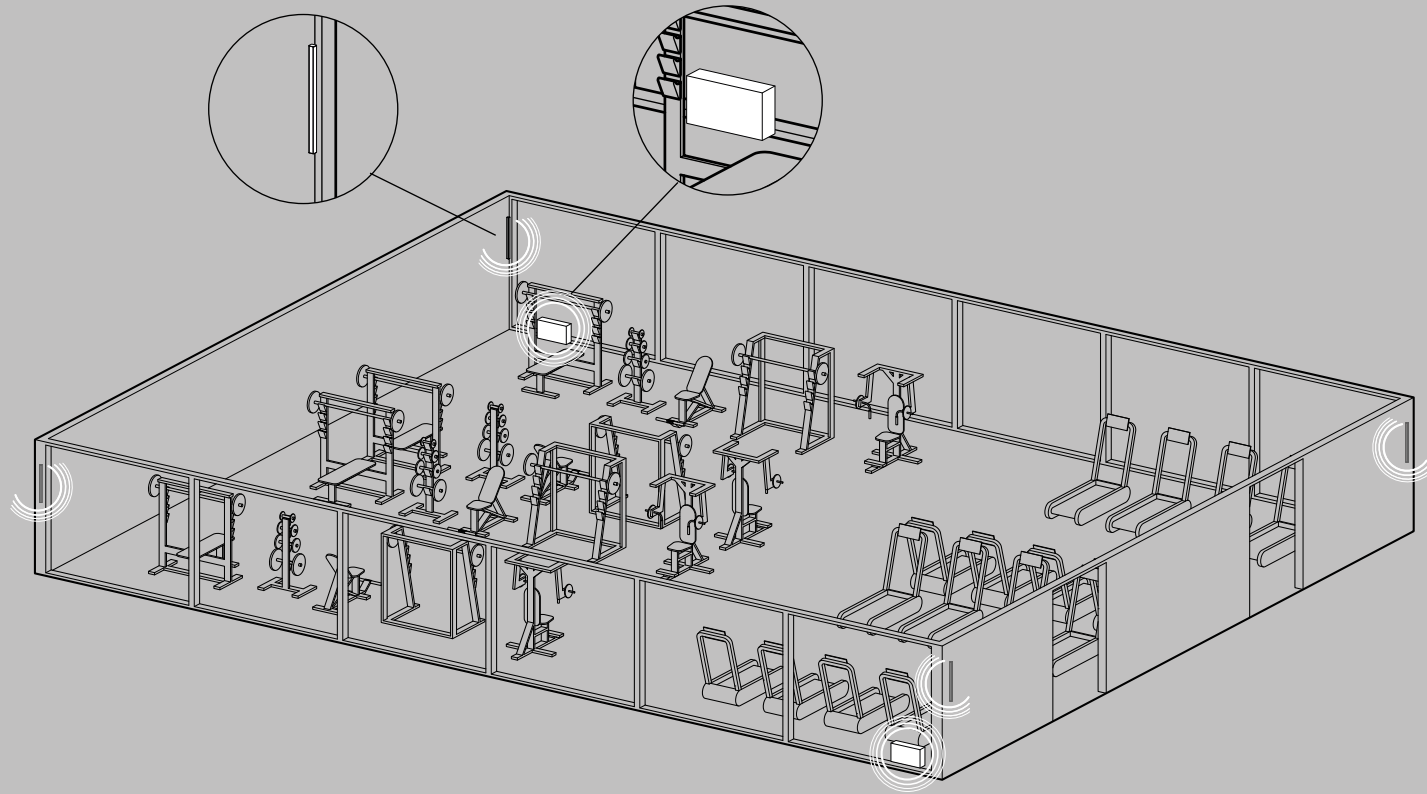

**Configuration 2**  
120 sq m / 1291 sq ft

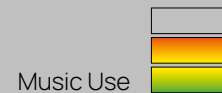

Conf.	Area	Speakers	Subwoofers	Amplifiers	Accessories
1	60 sq m (645 sq ft)	4x <b>GF42</b>	1x <b>GU210</b>	1x <b>GA41</b>	<b>G-RACK</b>
2	120 sq m (1291 sq ft)	4x <b>GF82</b>	2x <b>GU210</b>	1x <b>GA41</b>	<b>G-RACK</b>
3	180 sq m (1937 sq ft)	4x <b>GF162</b>	4x <b>GU210</b>	1x <b>GA41</b>	<b>G-RACK</b>



Fitness & Wellness

# FITNESS STUDIOS

## Configuration 2

120 sq m / 1291 sq ft

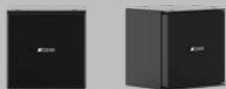
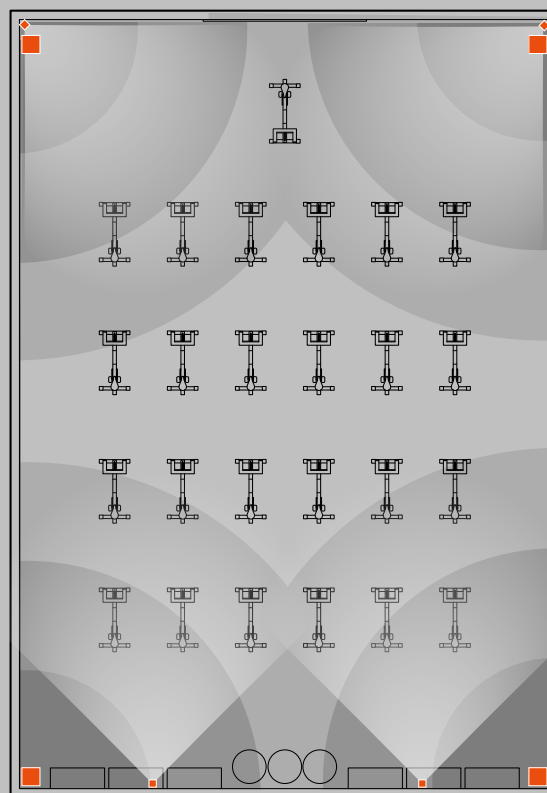
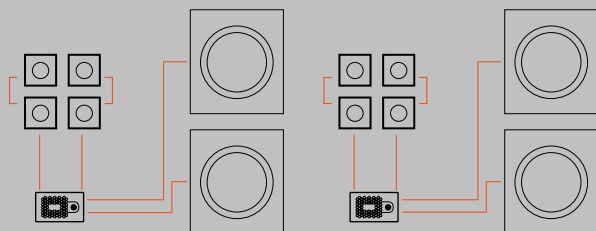

### GH4

Speaker  
112x112x94 mm  
1,2 kg



### GS12

Subwoofer  
410x445x430 mm  
19 kg

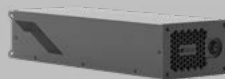

### GA43

Amplifier  
145x90x418 mm  
3,6 kg





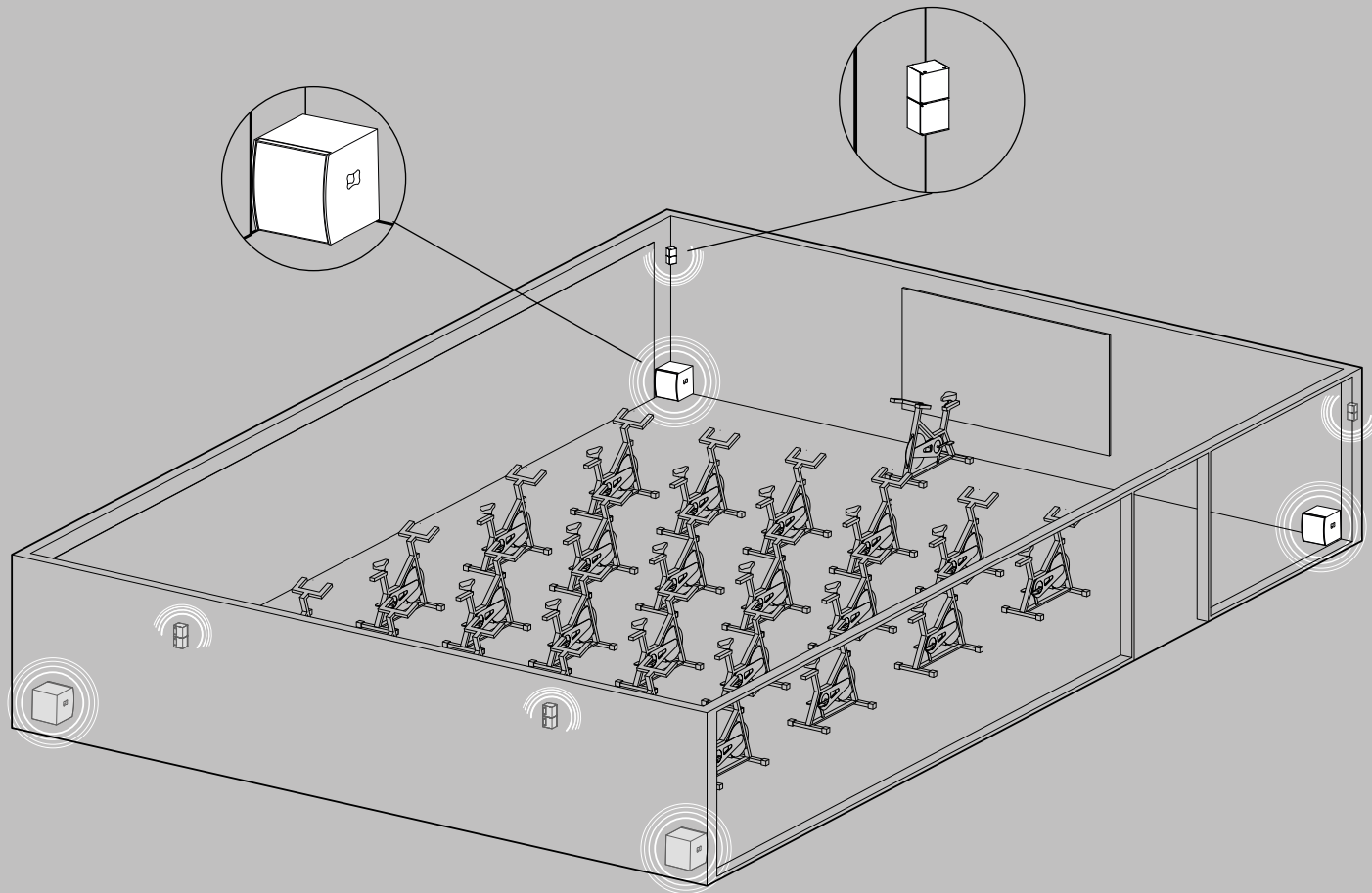

**Configuration 2**  
120 sq m / 1291 sq ft

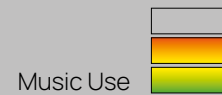

Conf.	Area	Speakers	Subwoofers	Amplifiers	Accessories
1	60 sq m (645 sq ft)	4x <b>GH4</b>	2x <b>GS12</b>	1x <b>GA43</b>	<b>G-RACK</b>
2	120 sq m (1291 sq ft)	8x <b>GH4</b>	4x <b>GS12</b>	2x <b>GA43</b>	<b>G-RACK</b>
3	180 sq m (1937 sq ft)	12x <b>GH4</b>	4x <b>GS18</b>	2x <b>GA46</b>	<b>G-RACK</b>

## HOSPITALITY & LEISURE

AUDIO SOLUTIONS



# Casinos

Amplify the gaming experience with dynamic audio precision.

Provide clear audio for entertainment venues and applications.

Craft distinct audio ambiances tailored to dining areas, bars, and lounges.

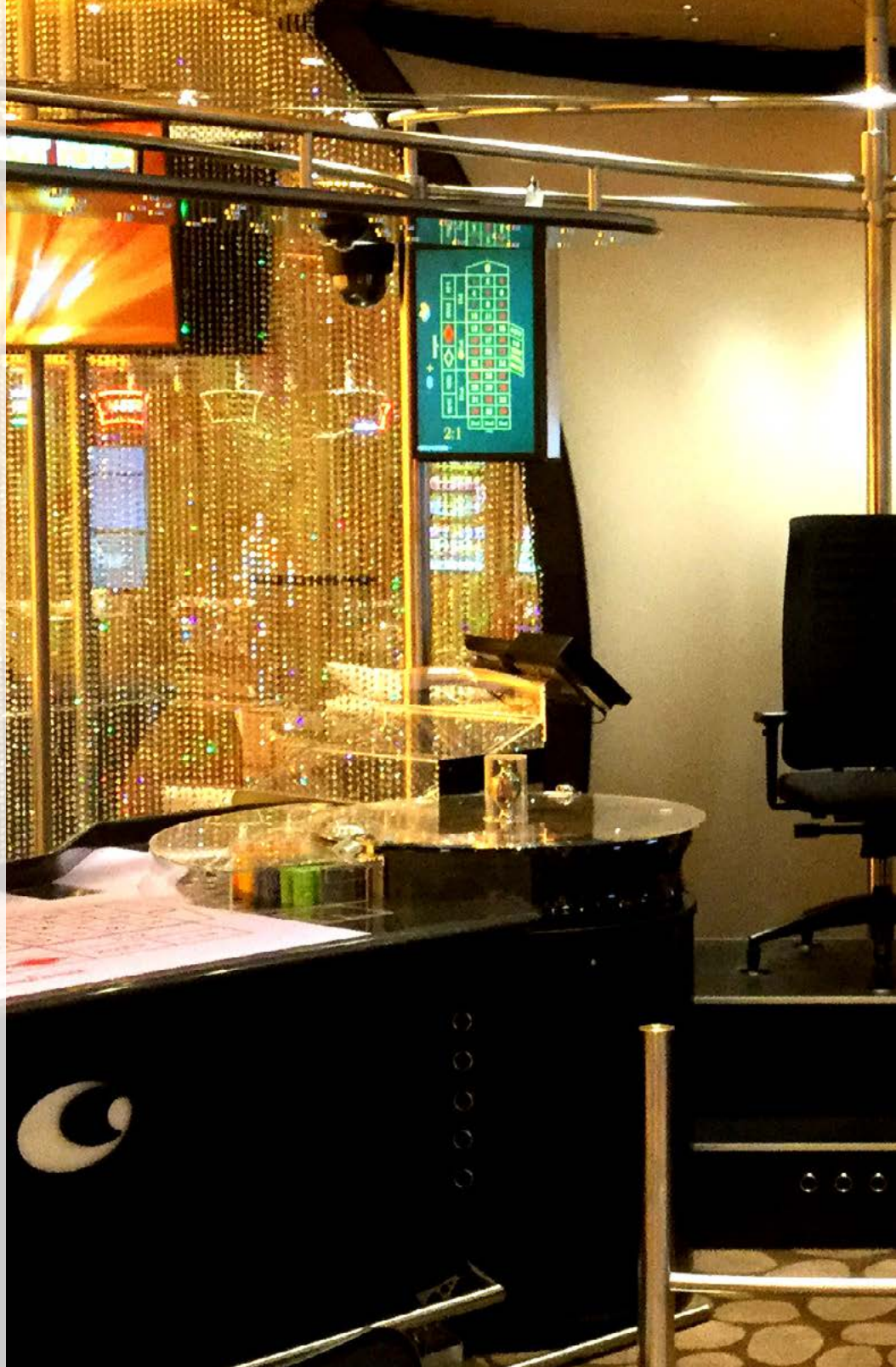

## GAMING HALLS





Casinos

# GAMING HALLS

Configuration 2

300 sq m / 3229 sq ft

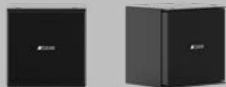
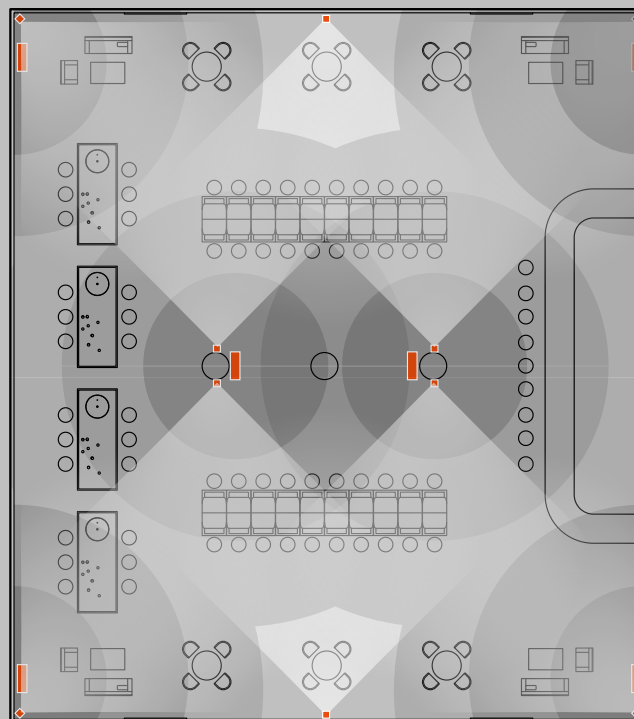
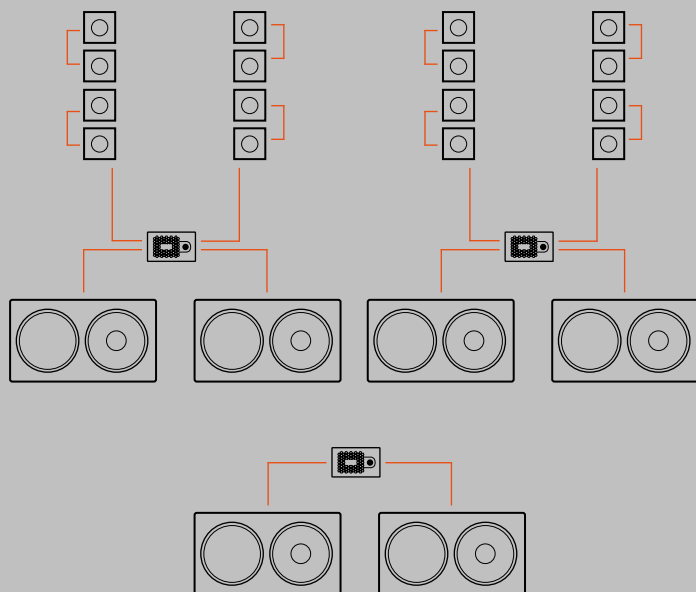

## GH4

Speaker  
112x112x94 mm  
1,2 kg



## GU210

Subwoofer  
556x200x116 mm  
7,9 kg

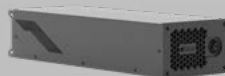

## GA43

Amplifier  
145x90x418 mm  
3,6 kg



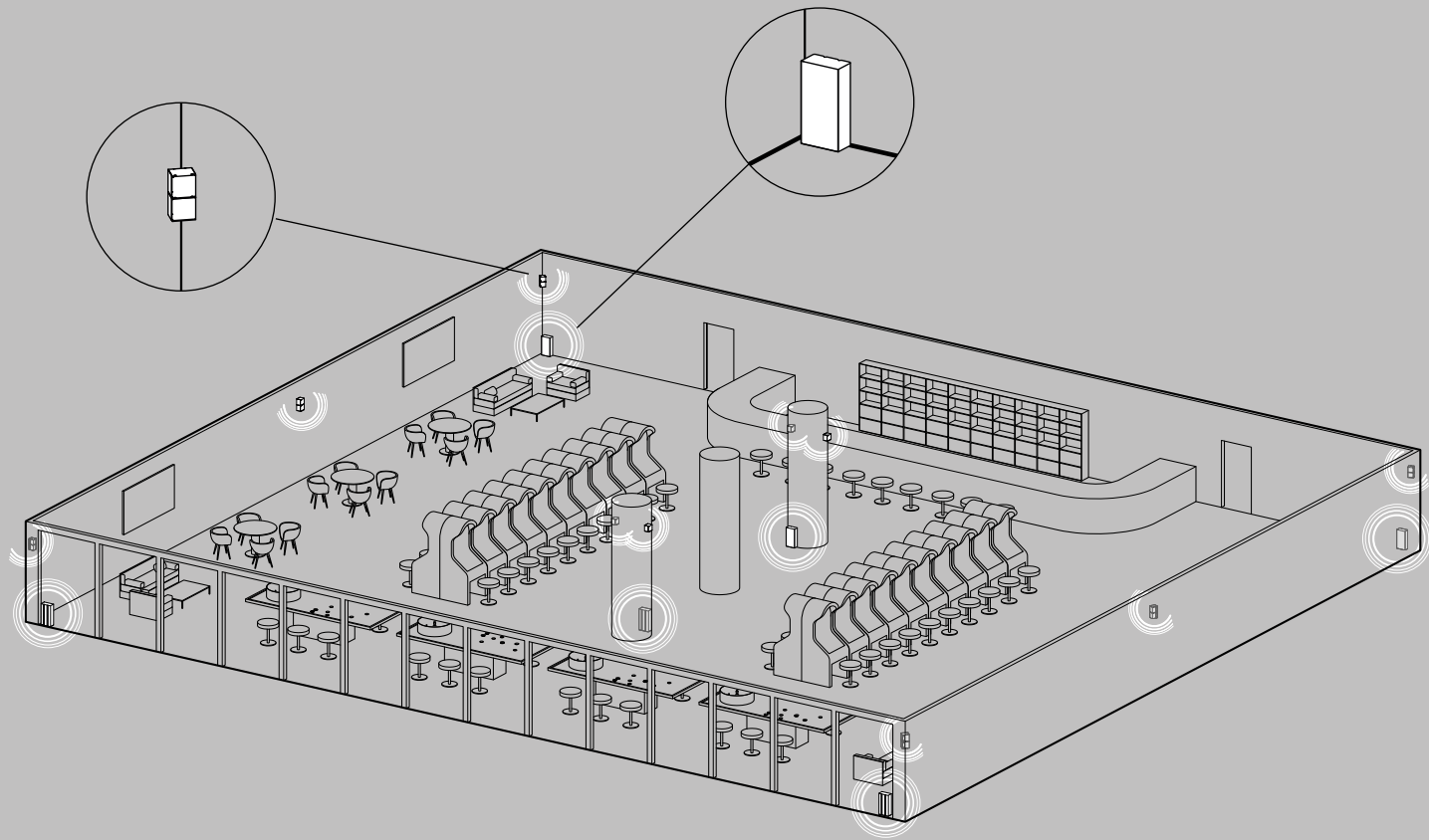

## Configuration 2

300 sq m / 3229 sq ft

Music Use 

Conf.	Area	Speakers	Subwoofers	Amplifiers	Accessories
1	150 sq m (1641 sq ft)	8x <b>GH4</b>	4x <b>GU210</b>	1x <b>GA43</b>	<b>G-RACK</b>
2	300 sq m (3229 sq ft)	16x <b>GH4</b>	6x <b>GU210</b>	3x <b>GA43</b>	<b>G-RACK</b>

## HOSPITALITY & LEISURE

AUDIO SOLUTIONS



# Nightclubs & Lounges

Fuel the dance floor with the undeniable strength of sound. KGEAR delivers competitive, high-quality audio that drives the spirit of nightlife. With a commitment to powerful sound reinforcement without compromising quality, KGEAR ensures that every note, from deep bass to shimmering highs, resonates with clarity.

The energy of the crowd, the rhythm of the night, and the shared euphoria are amplified by KGEAR's robust systems, bringing everyone together in a shared celebration of sound and dance.



## NIGHTCLUBS





Nightclubs & Lounges

# DANCE FLOOR AREA

Configuration 2

400 sq m / 4305 sq ft

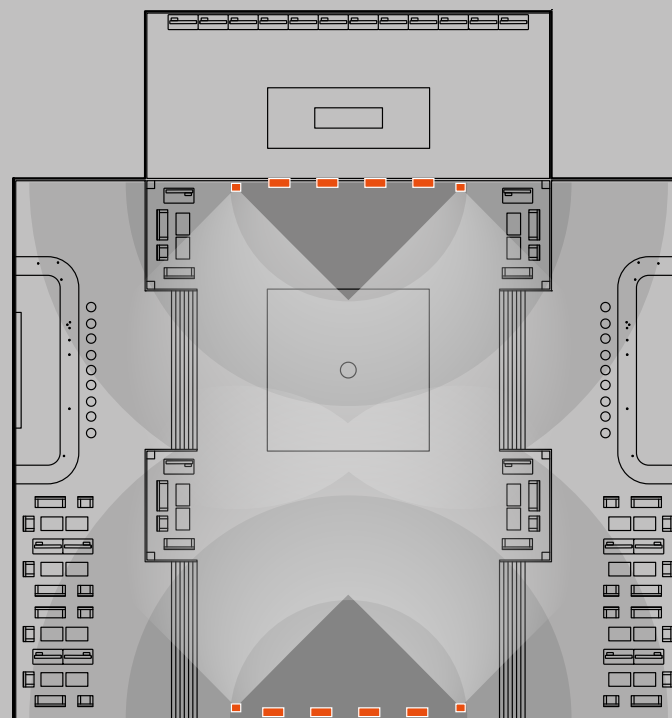
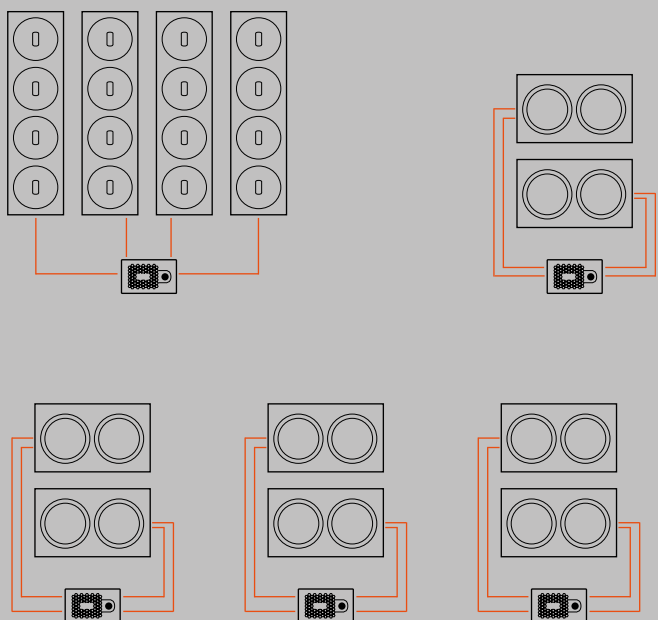

**GH412**

Speaker  
327x1290x198 mm  
55,2kg



**GS218**

Subwoofer  
1035x614x600 mm  
58 kg

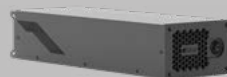

**GA46**

Amplifier  
145x90x418 mm  
3,8 kg





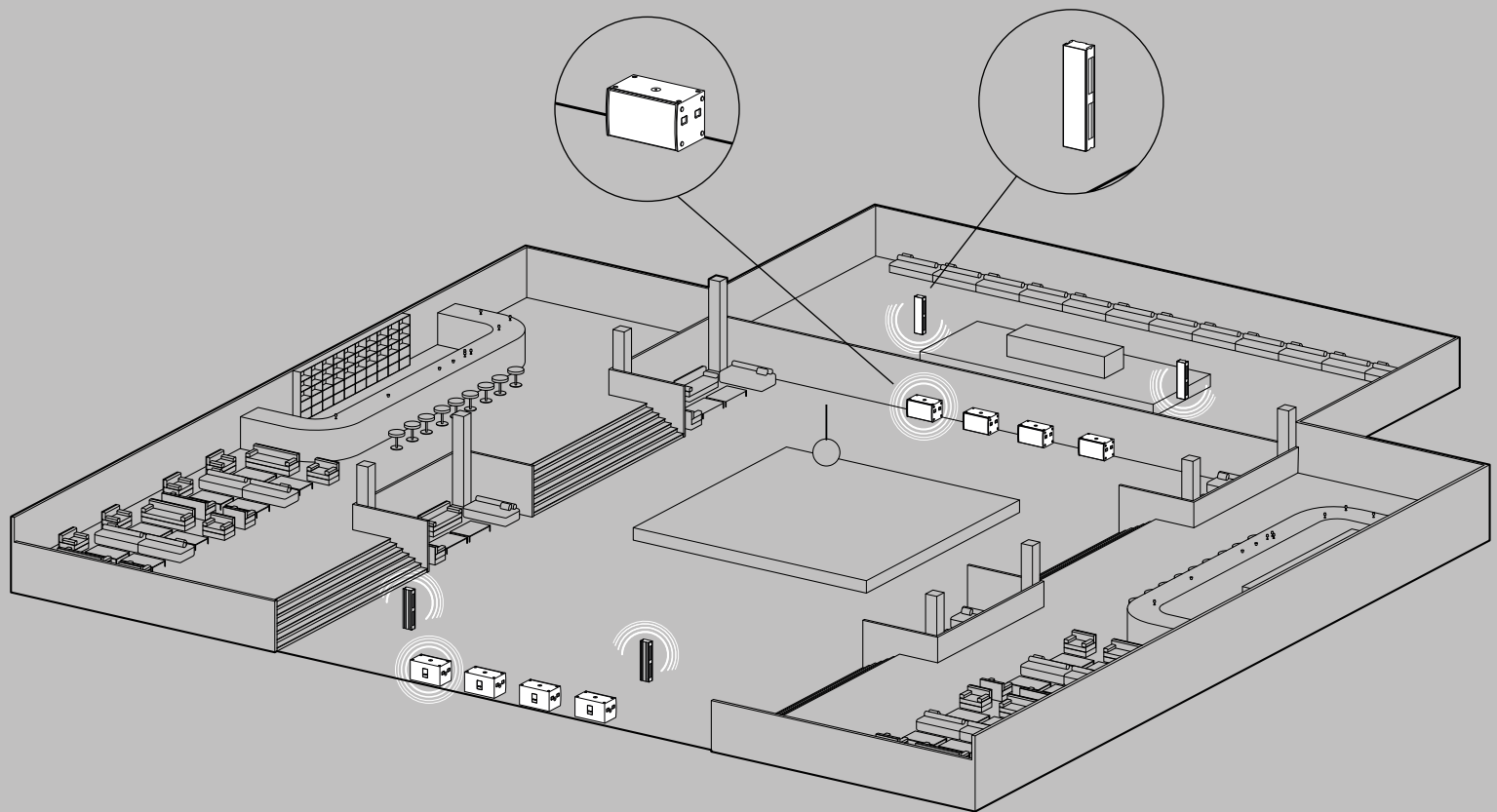

## Configuration 2

400 sq m / 4305 sq ft

Music Use 

Conf.	Area	Speakers	Subwoofers	Amplifiers	Accessories
1	120 sq m (1291 sq ft)	8x <b>GH12</b>	4x <b>GS218</b>	2x <b>GA46</b>	<b>G-RACK</b>
2	400 sq m (4305 sq ft)	4x <b>GH412</b>	8x <b>GS218</b>	5x <b>GA46</b>	2x <b>G-RACK</b>

# **K**SCAPE

Merging Senses



Hotel and Resort

P.  
100



Restaurants and Cafes

108



Fitness and Wellness Centers

116

## Envelop Your Space in KSCAPE's Sonic & Lighting Symphony

In the Hospitality & Leisure industry, creating a captivating atmosphere for guests is essential for delivering memorable experiences.

KSCAPE offers a distinctive selection of audio-lighting solutions specifically designed for various applications within this sector, including hotels, resorts, restaurants, bars, cafes, fitness centers, and casinos. Our unique product lineup empowers industry professionals to address common audio challenges while enriching the ambiance of their spaces through the seamless fusion of light and sound.

With KSCAPE, you can elevate your projects by crafting visually and audibly immersive environments tailored to your guests' needs.



## Hotels and Resorts

Equip hotel lobbies, guest rooms, and conference facilities with KSCAPE's audio-lighting solutions, providing clear and balanced audio while enhancing the visual atmosphere.

Implement KSCAPE's audio-lighting systems for intelligible communication in public spaces.

Create immersive experiences in hotel spa areas with KSCAPE's combination of soothing audio and adjustable lighting.

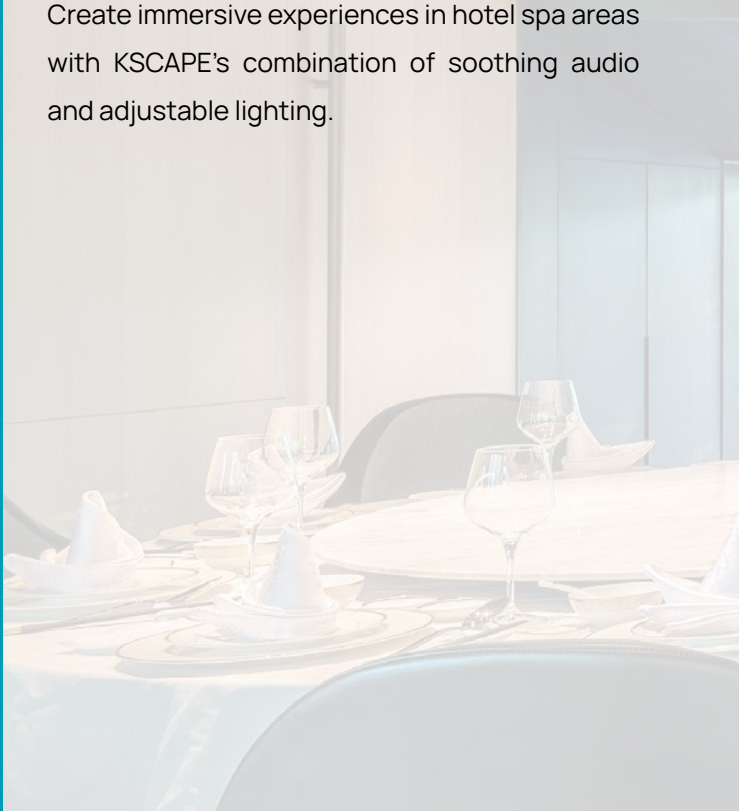





Hotels & Resorts

# RECEPTION COUNTERS

Configuration 2

90 sq m / 968 sq ft

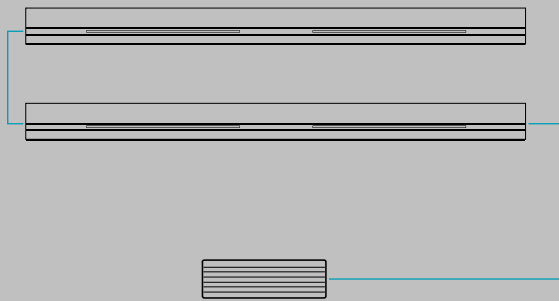

**R120-SY-V-DI-B-AU**

Speaker + Light  
1190x35x92 mm  
3 kg



**Kommander-S-KA04 I**

Amplifier  
219 x 45,5 x 170 mm  
0,7 kg

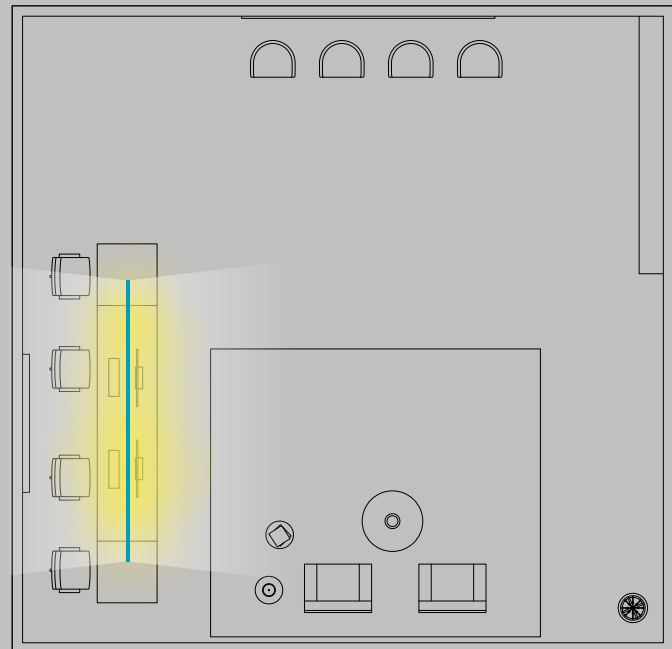



## Configuration 2

90 sq m / 968 sq ft

Considered Height: 4m

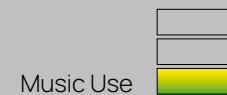

Conf.	Area	Rail	Subwoofers	Amplifiers	Accessories
1	40 sq m (430 sq ft)	1x R120-SY-V-DI-B-AU	/	1x <b>Kommander-S-KA04 I</b>	1x S-AL100-24 2x RTB 1X PEN2-120
2	90 sq m (968 sq ft)	2x R120-SY-V-DI-B-AU	/	1x <b>Kommander-S-KA04 I</b>	1x S-AL150-24 4x RTB 2X PEN2-120
3	180 sq m (1937 sq ft)	4x R120-SY-V-DI-B-AU	/	1x <b>Kommander-S-KA04 I</b>	1x S-AL250-24 8x RTB 4X PEN2-120



Hotels & Resorts

# LOBBIES & LOUNGES

## Configuration 2

90 sq m / 968 sq ft

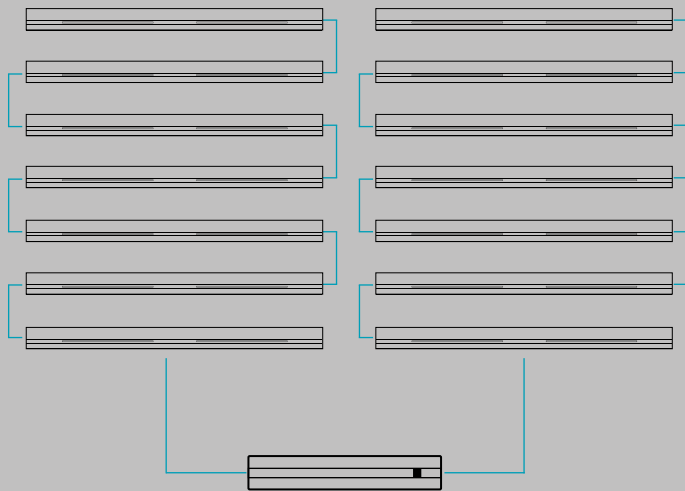

**R120-DF-D-DL-W-AU**

Speaker + Light  
1190x35x92 mm  
3 kg



**Kommander-S-KA14 I**

Amplifier  
430 x 87 x 430 mm  
6 kg

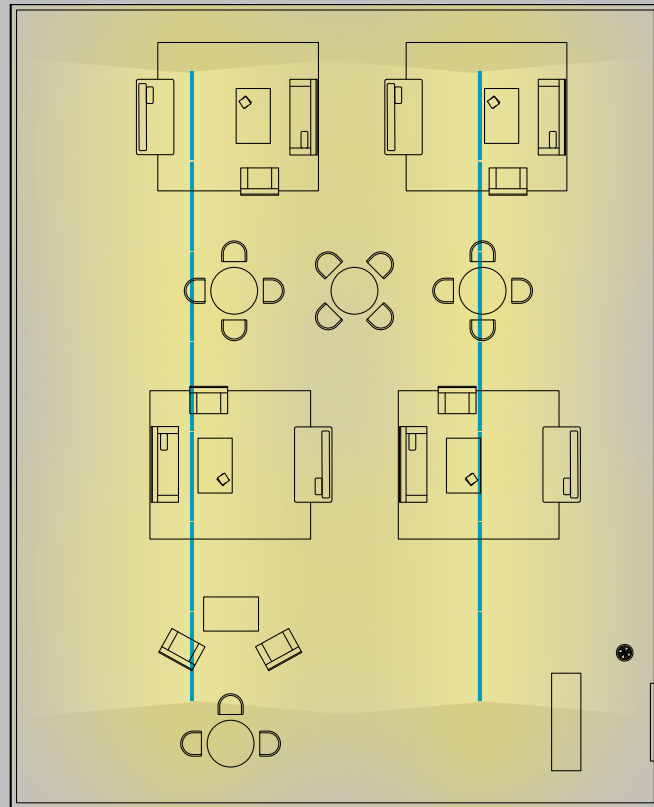



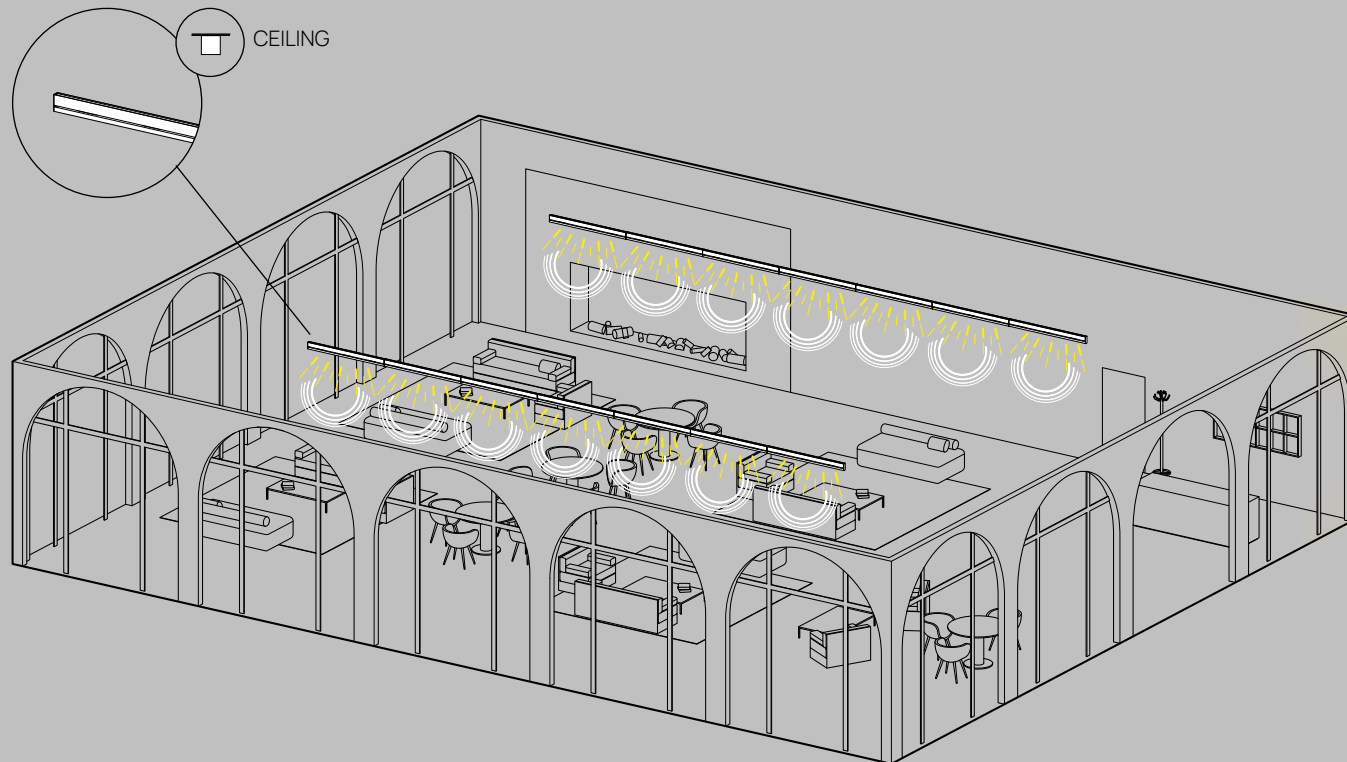

## Configuration 2

90 sq m / 968 sq ft

Considered Height: 4m

Music Use

Conf.	Area	Rail	Subwoofers	Amplifiers	Accessories
1	40 sq m (430 sq ft)	8x R120-DF-D-DL-W-AU	/	1x <b>Kommander-S-KA14 I</b>	2x S-AL200-24 4x RTW 2x PLA1-120 + 6x PLA2-120
2	90 sq m (968 sq ft)	14x R120-DF-D-DL-W-AU	/	1x <b>Kommander-S-KA14 I</b>	2x S-AL300-24 4x RTW 2x PLA1-120 + 12x PLA2-120
3	180 sq m (1937 sq ft)	24x R120-DF-D-DL-W-AU	/	1x <b>Kommander-S-KA14 I</b>	6x S-AL200-24 8x RTW 4 PLA1-120 + 20 PLA2-120



Hotels & Resorts

# ROOMS

Configuration 1

15 sq m / 161 sq ft

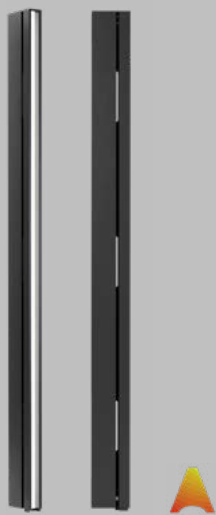
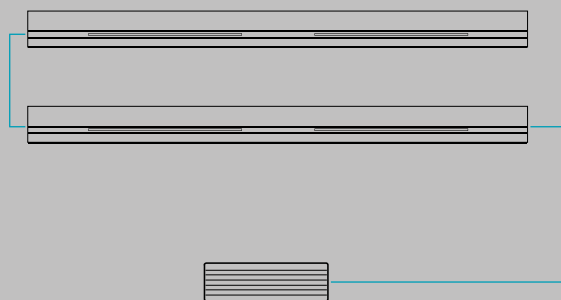

**R120-AS-C-CX-W-AU**

Speaker + Light  
1190x35x92 mm  
3 kg



**Kommander-S-KA04 I**

Amplifier  
219 x 45,5 x 170 mm  
0,7 kg

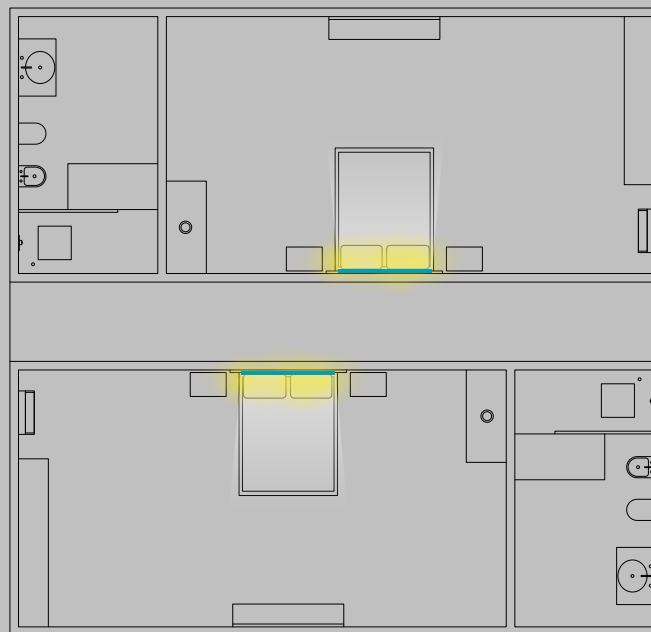

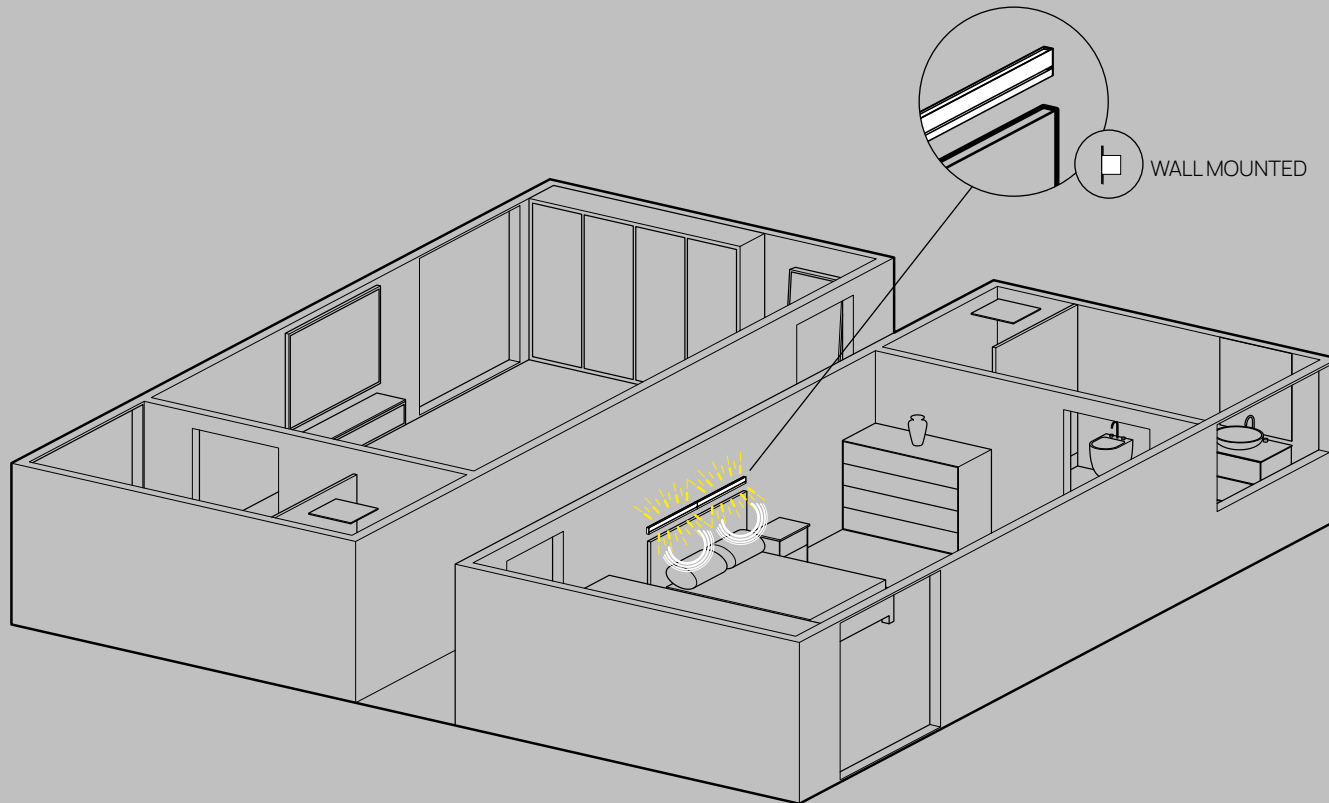

### Configuration 1

15 sq m / 161 sq ft

Considered Height: 4m

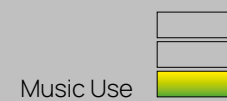

Conf.	Area	Rail	Subwoofers	Amplifiers	Accessories
1	15 sq m (161 sq ft)	1x R120-AS-C-CX-W-AU	/	1x <b>Kommander-S-KA04 I</b>	1x S-AL100-24 2x RTW 1x APP-120
2	50 sq m (538 sq ft)	1x R120-DF-C-CX-B-AU	/	1x <b>Kommander-S-KA04 I</b>	1x S-AL100-24 2x RTB 1x PEN2-120



## Restaurants and Cafes

Create the perfect ambiance with KSCAPE's audio-lighting systems, ensuring a pleasant dining experience for guests with synchronized light and sound.

Utilize KSCAPE's discreet and slim-profile solutions to seamlessly integrate into the decor, preserving aesthetics while delivering high-quality audio and customizable lighting.

Address acoustic challenges and control sound levels with KSCAPE's speaker systems, ensuring a comfortable and enjoyable atmosphere for diners.

2  
To o

LUB  
until 2100





Restaurants & Cafes

# DINING ROOMS

Configuration 2

90 sq m / 645 sq ft

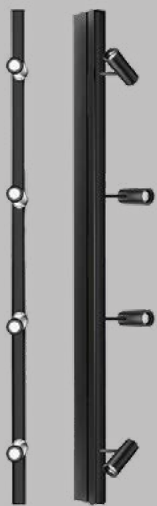
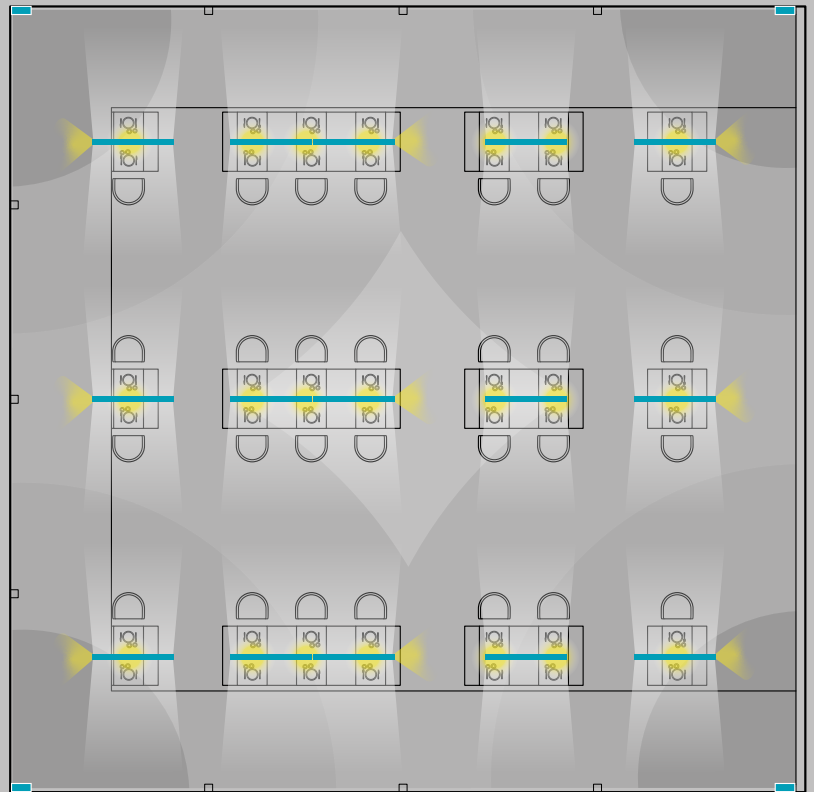
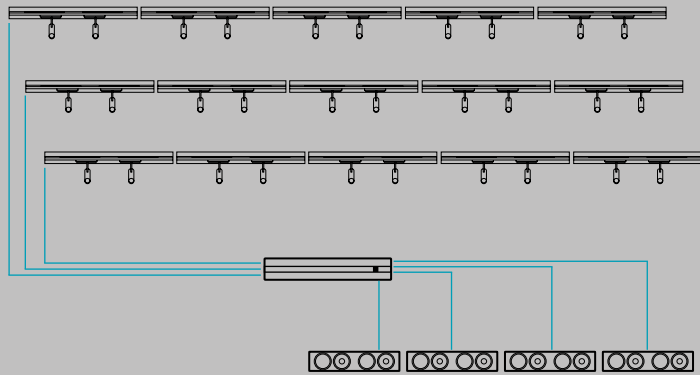

**R120-EO-V-DL-B-AU**

Speaker + Light  
1190x35x92 mm  
3 kg



**SPOT-55-AL-X-C**

Spot



**Rumble-S-KU44**

Subwoofer  
219 x 45,5 x 170 mm  
0,7 kg

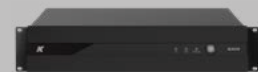

**Kommander-S-KA28**

Amplifier  
430 x 87 x 430 mm  
7,4 kg



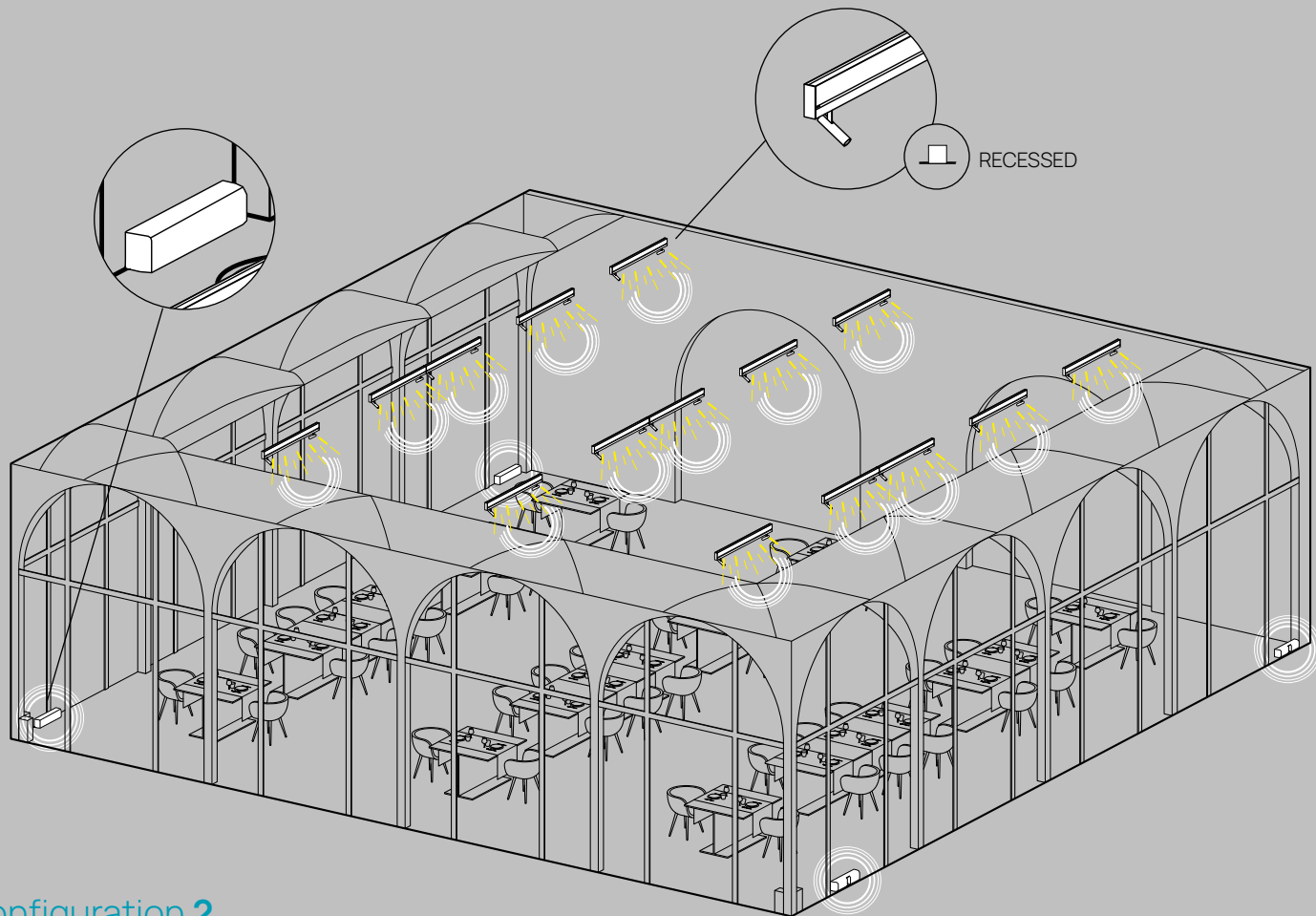

## Configuration 2

90 sq m / 968 sq ft

Considered Height: 3,5m

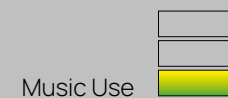

Conf.	Area	Rail	Subwoofers	Amplifiers	Accessories
1	60 sq m (645 sq ft)	8x R120-EO-V-DL-B-AU 6x SPOT-55-AL-X-C	4x <b>Rumble-S-KU44</b>	1x <b>Kommander-S-KA14 I</b>	2x S-AL200-24 8x HS-FL-ST-120-B 16x RTB
2	90 sq m (968 sq ft)	15x R120-EO-V-DL-B-AU 30x SPOT-55-AL-X-C	4x <b>Rumble-S-KU44</b>	1x <b>Kommander-S-KA28</b>	3x S-AL200-24 9x HS-FL-ST-120-B + 6x HS-FL-ED-120-B + 24x RTB
3	180 sq m (1937 sq ft)	24x R120-EO-V-DL-B-AU 48x SPOT-55-AL-X-C	4x <b>Rumble-S-KU44</b>	1x <b>Kommander-S-KA28</b>	3x S-AL200-24 6x HS-FL-ST-120-B + 12x HS-FL-ED-120-B 6x HS-FL-MI-120-B + 24x RTB



Restaurants & Cafes

# BAR COUNTERS

Configuration 2

60 sq m / 645 sq ft

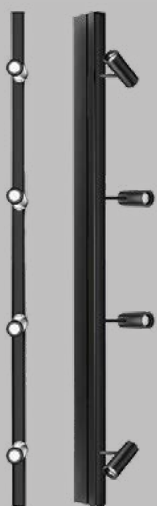
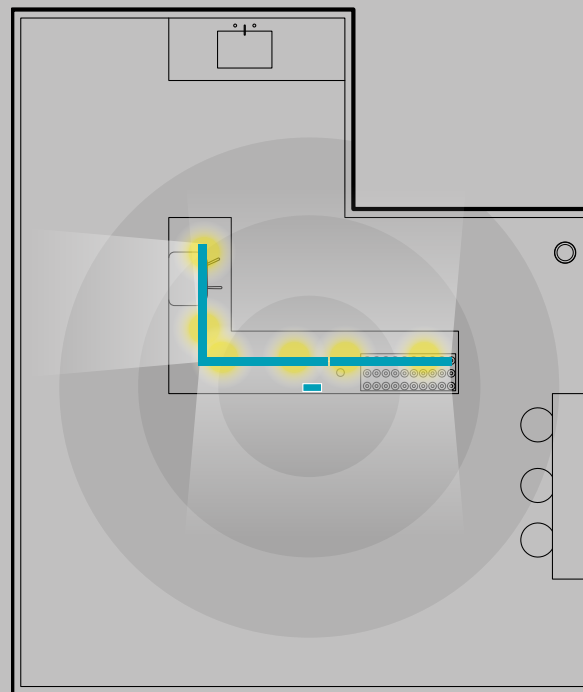
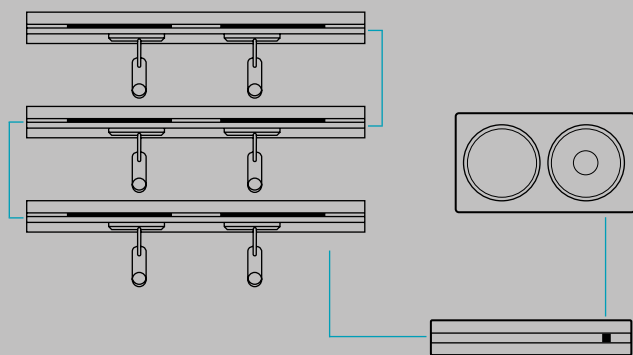

**R120-EO-V-DL-B-AU**

Speaker + Light  
1190x35x92 mm  
3 kg



**SPOT-55-AL-B**

Spot



**Rumble-S-KU26**

Subwoofer  
350 x 180 x 118 mm  
5,9 kg



**Kommander-S-KA04 I**

Amplifier  
219 x 45,5 x 170 mm  
0,7 kg





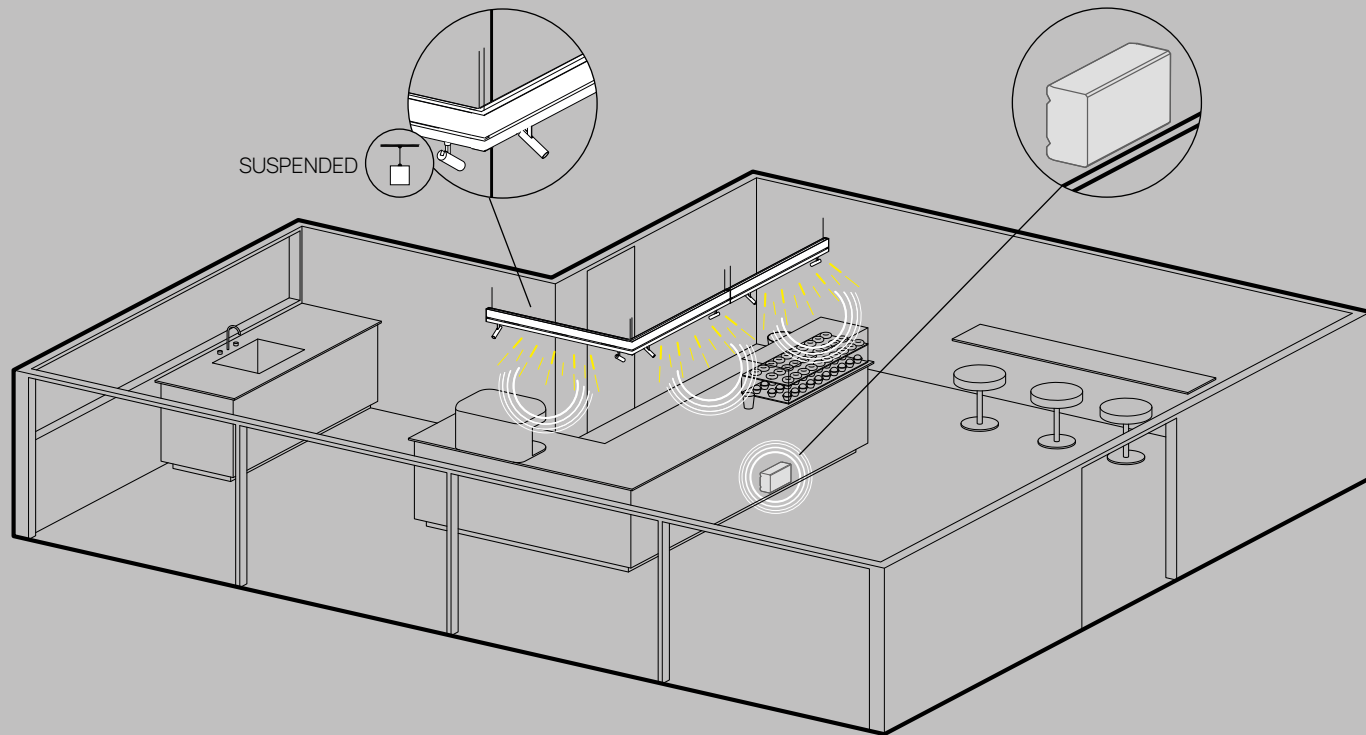

## Configuration 2

60 sq m / 645 sq ft

Considered Height: 4m

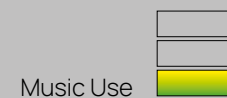

Conf.	Area	Rail	Subwoofers	Amplifiers	Accessories
1	30 sq m (322 sq ft)	1x R120-EO-V-DL-B-AU 4x SPOT-55-AL-B	/	1x <b>Kommander-S-KA04 I</b>	1x S-AL-100-24 2x RTB 1X PEN2-120
2	60 sq m (645 sq ft)	3x R120-EO-V-DL-B-AU 12x SPOT-55-AL-B	1x <b>Rumble-S-KU26</b>	1x <b>Kommander-S-KA04 I</b>	1x S-AL-300-24 1x RTLDXB 2x RTB / 3X PEN2-120
3	90 sq m (968 sq ft)	3x R120-EO-V-DL-B-AU 24x SPOT-55-AL-B	1x <b>Rumble-S-KU26</b>	1x <b>Kommander-S-KA04 I</b>	1x S-AL-100-24 2x RTB 6X PEN2-120



Restaurants & Cafes

## CAFES

Configuration 2

60 sq m / 645 sq ft

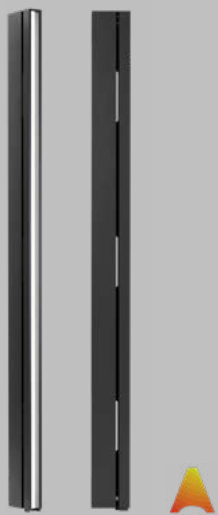
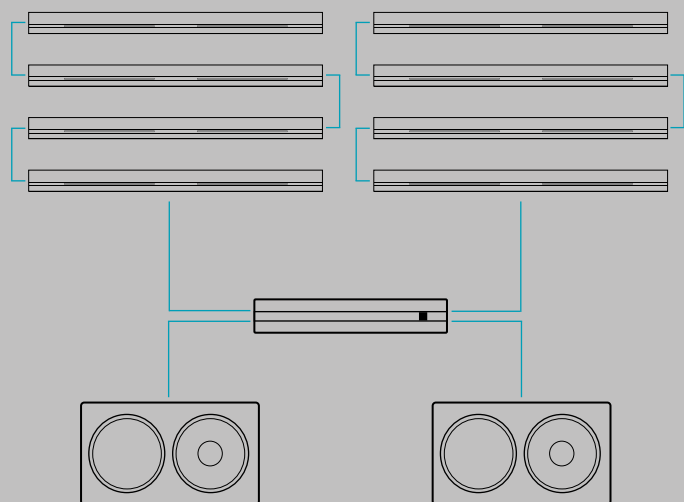

**R120-DF-C-DL-W-AU**

Speaker + Light  
1190x35x92 mm  
3 kg



**Rumble-S-KU26**

Subwoofer  
350 x 180 x 118 mm  
5,9 kg

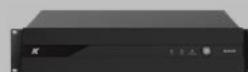

**Kommander-S-KA14 I**

Amplifier  
430 x 87 x 430 mm  
6 kg

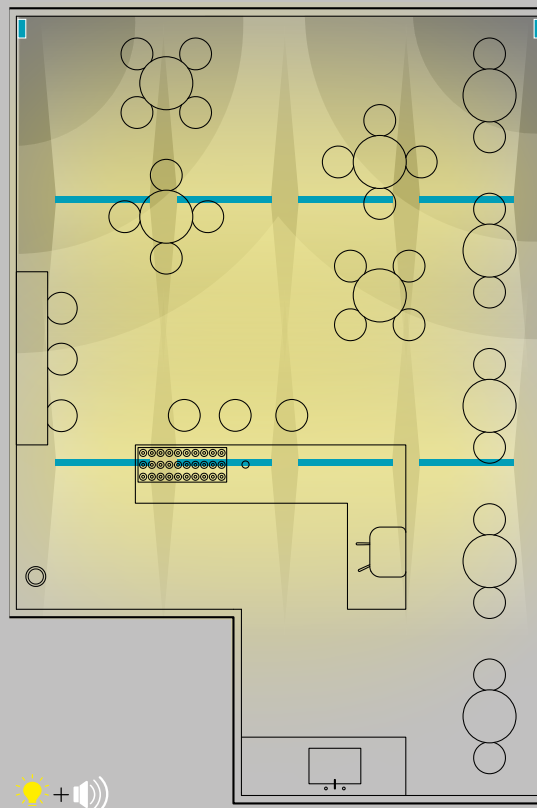

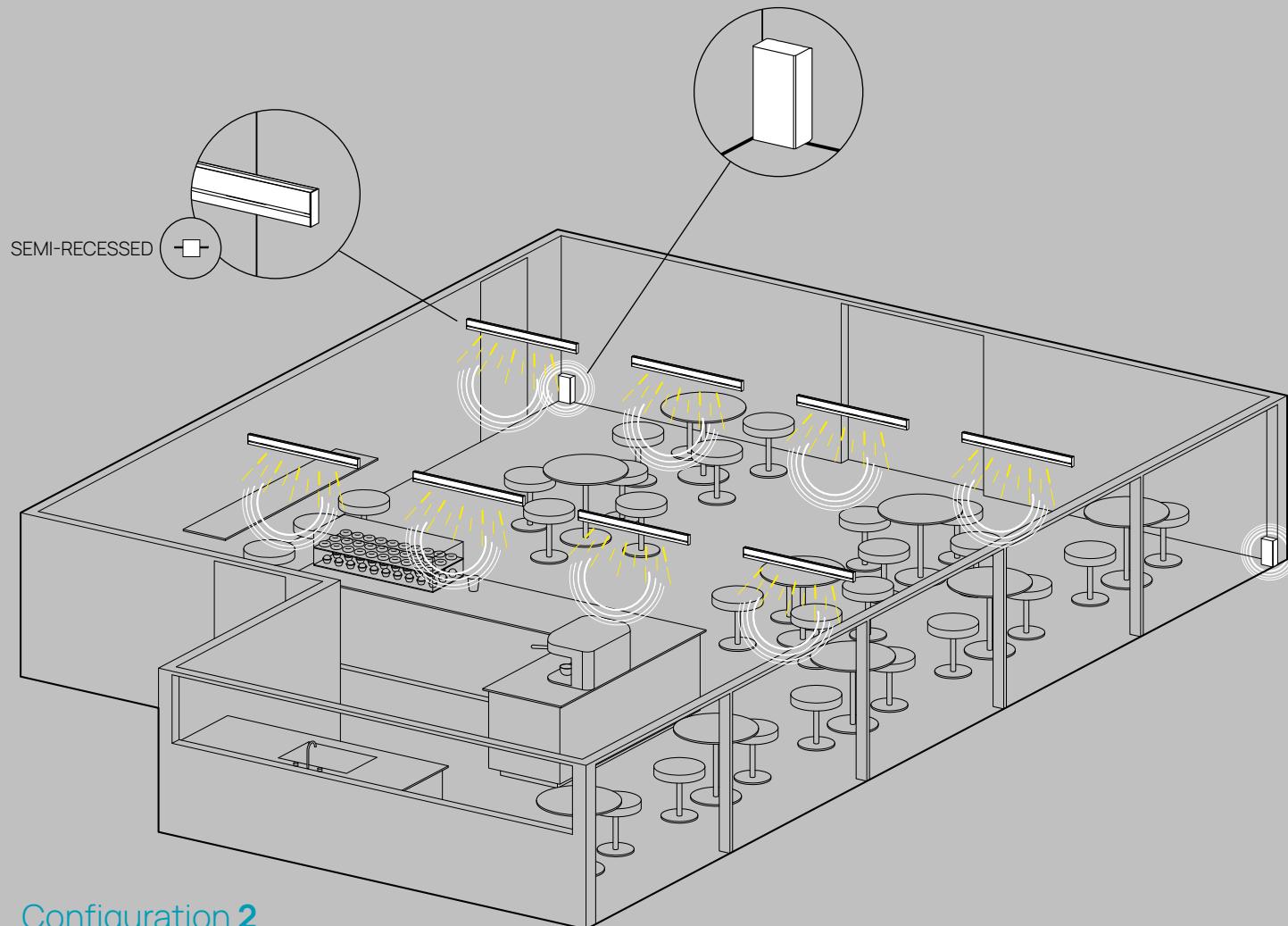

## Configuration 2

60 sq m / 645 sq ft

Considered Height: 3 m

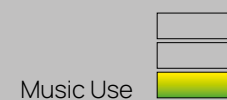

Conf.	Area	Rail	Subwoofers	Amplifiers	Accessories
1	30 sq m (322 sq ft)	6x R120-DF-C-DL-W-AU	1x <b>Rumble-S-KU26</b>	1x <b>Kommander-S-KA14 I</b>	6x HS-SF-ST-120-W 12x RTW 1x S-AL300-24
2	60 sq m (645 sq ft)	8x R120-DF-C-DL-W-AU	2x <b>Rumble-S-KU26</b>	1x <b>Kommander-S-KA14 I</b>	8x HS-SF-ST-120-W 16x RTW 2x S-AL200-24
3	90 sq m (968 sq ft)	12x R120-DF-C-DL-W-AU	1x <b>Rumble-S-KU26</b>	1x <b>Kommander-S-KA14 I</b>	12x HS-SF-ST-120-W 24x RTW 2x S-AL300-24

## HOSPITALITY & LEISURE

LIGHT & AUDIO SOLUTIONS



# Fitness and Wellness Centers

Equip workout areas with KSCAPE's audio-lighting solutions, ensuring an engaging audio atmosphere for instructors and participants with customizable lighting.

Install unobtrusive in-ceiling KSCAPE solutions in relaxation, meditation areas and waiting rooms, providing soothing background music and ambient lighting to enhance the calming environment.



## WELLNESS





Fitness & Wellness Centers

# WAITING AREAS

Configuration 1

15 sq m / 161 sq ft

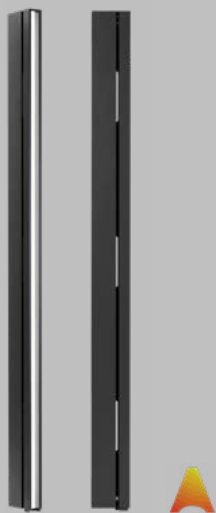
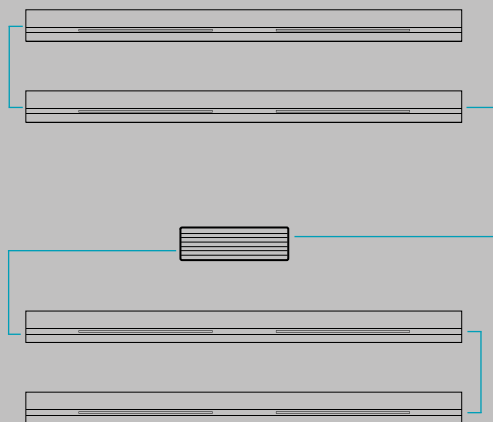

R120-DF-C-CL-W-AU

Speaker + Light  
1190x35x92 mm  
3 kg



**Kommander-S-KA04 I**

Amplifier  
219 x 45,5 x 170 mm  
0,7 kg

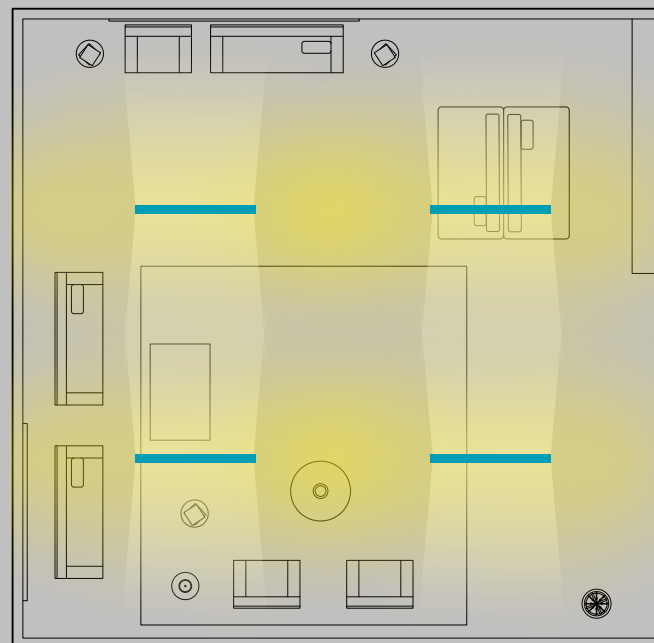

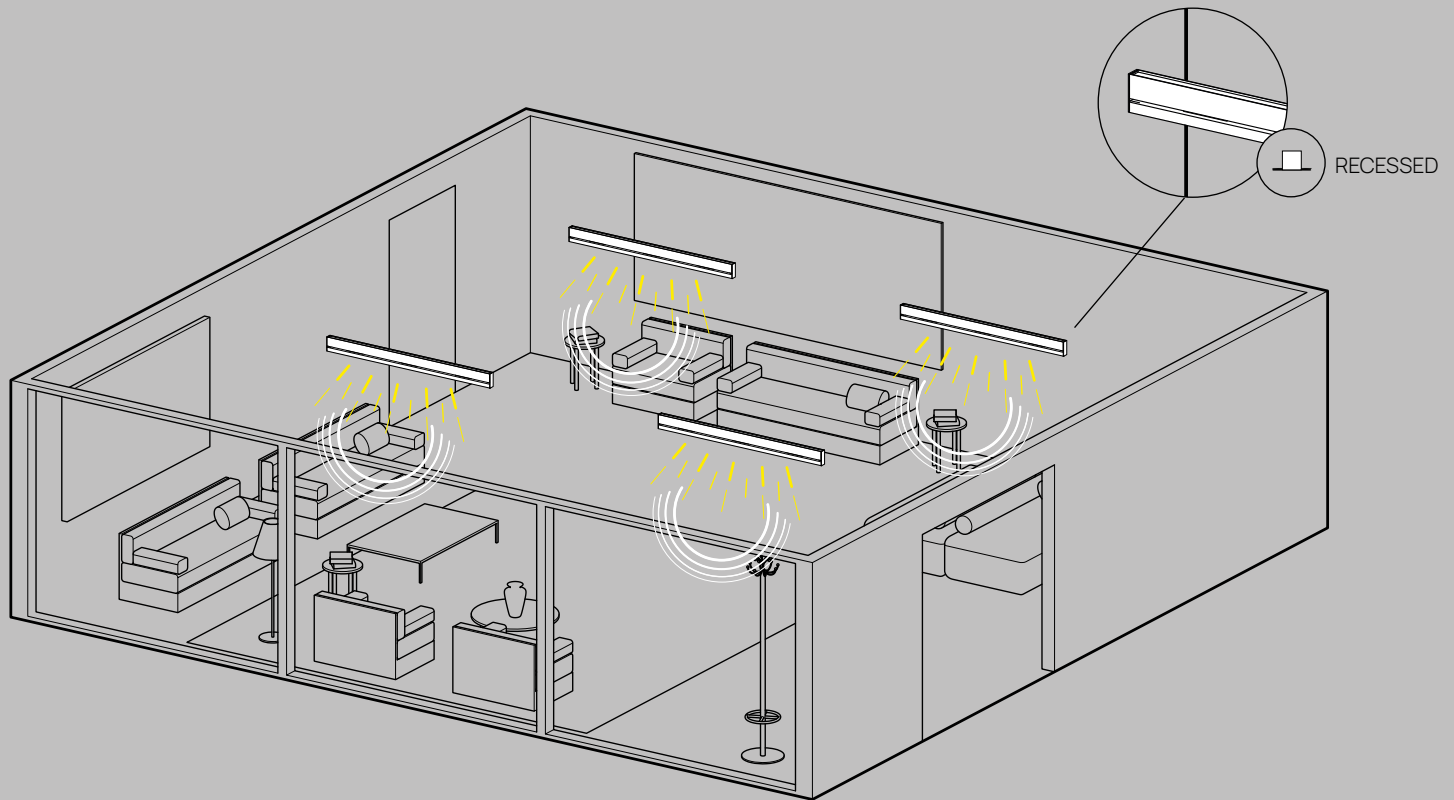

### Configuration 1

15 sq m / 161 sq ft

Considered Height: 4m

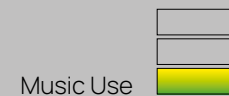

Conf.	Area	Rail	Subwoofers	Amplifiers	Accessories
1	15 sq m (161 sq ft)	4x R120-DF-C-CL-W-AU	/	1x <b>Kommander-S-KA04 I</b>	1x S-AL290-24 4x HS-FL-ST-120-W 8x RTW



Fitness & Wellness Centers

# WELLNESS AREAS

## Configuration 1

12 sq m / 129 sq ft

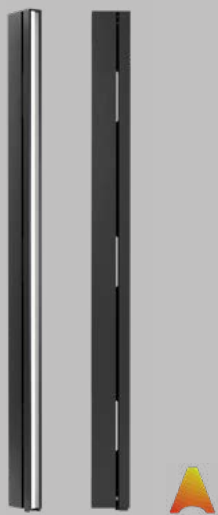
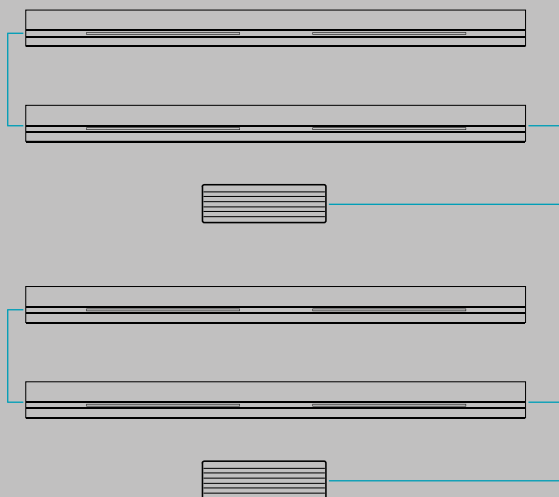

**R120-DF-D-CL-W-AU**

Speaker + Light  
1190x35x92 mm  
3 kg



**Kommander-S-KA04 I**

Amplifier  
219 x 45,5 x 170 mm  
0,7 kg

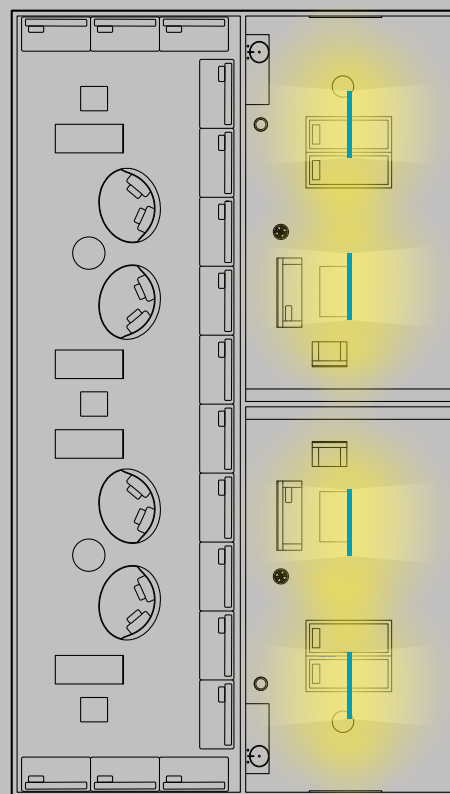



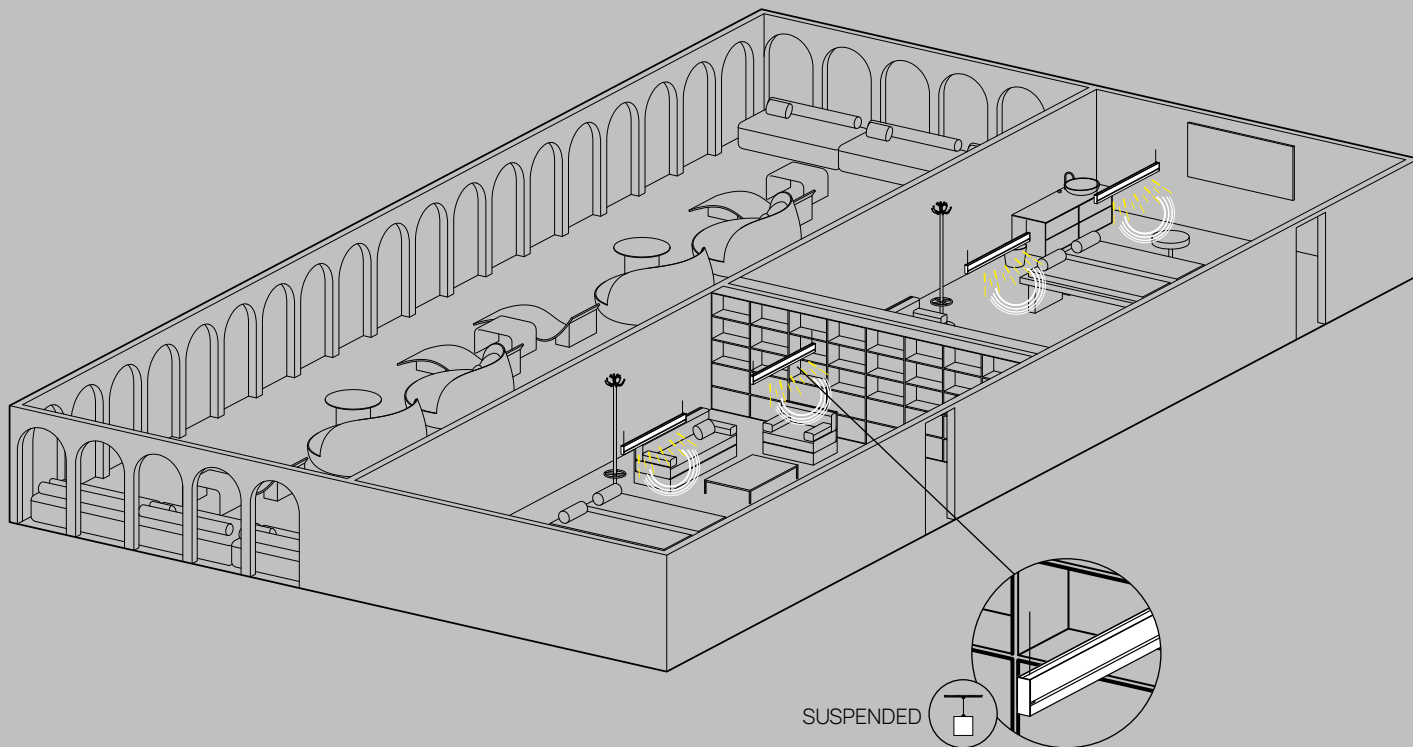

### Configuration 1

12 sq m / 129 sq ft

Considered Height: 4m

Music Use 

Conf.	Area	Rail	Subwoofers	Amplifiers	Accessories
1	12 sq m (129 sq ft)	4x R120-DF-C-CX-W-AU	/	2x <b>Kommander-S-KA04 I</b>	2x S-AL200-24 8x RTW 4x PEN2-120



Fitness & Wellness Centers

# WELLNESS AREAS

## Configuration 1

50 sq m / 538 sq ft

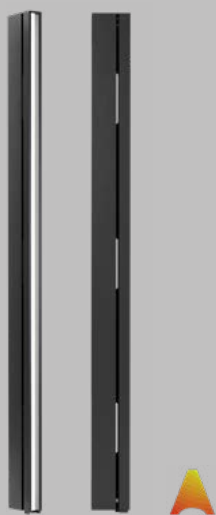
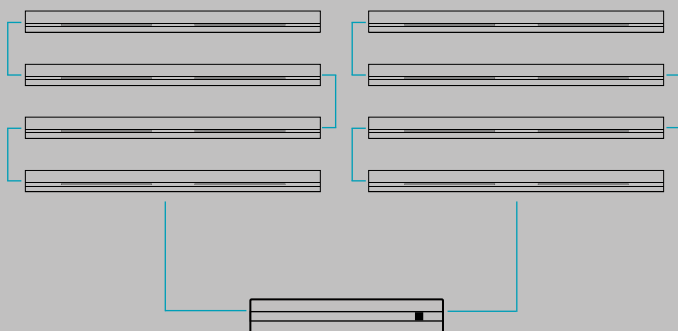

**R120-DF-D-CL-W-AU**

Speaker + Light  
1190x35x92 mm  
3 kg



**Kommander-S-KA04 I**

Amplifier  
219 x 45,5 x 170 mm  
0,7 kg

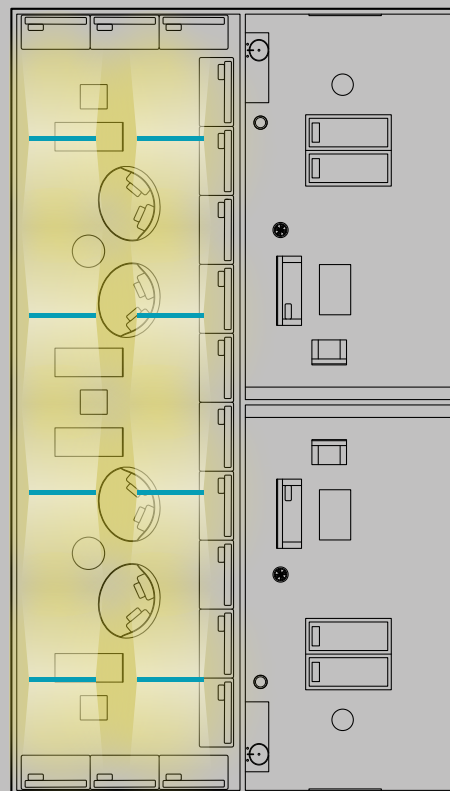

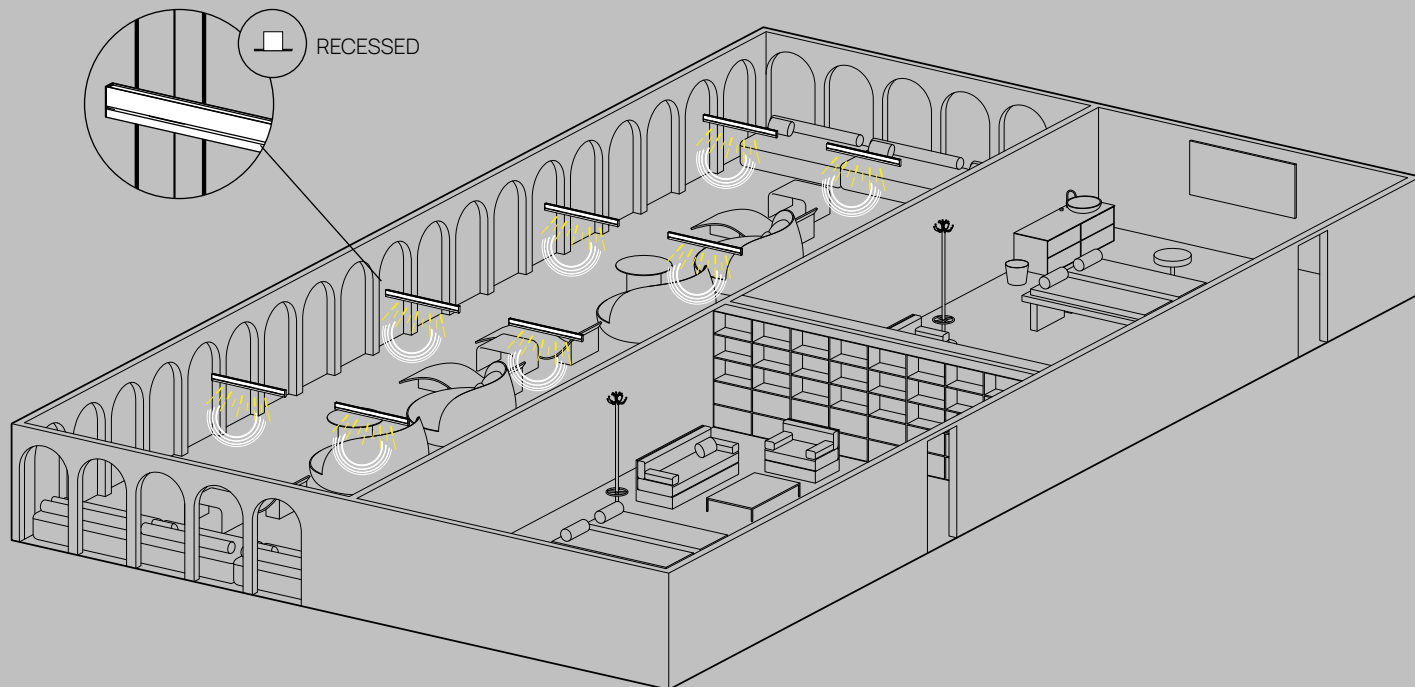

### Configuration 1

50 sq m / 538 sq ft

Considered Height: 4m

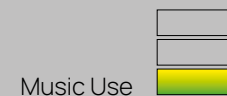

Conf.	Area	Rail	Subwoofers	Amplifiers	Accessories
1	50 sq m (538 sq ft)	8x R120-DF-D-CL-W-AU	/	1x <b>Kommander-S-KA04 I</b>	2x S-AL200-24 16x RTW 8x HS-FL-ST-120-W



Fitness & Wellness Centers

# GYMS

## Configuration 2

120 sq m / 1291 sq ft

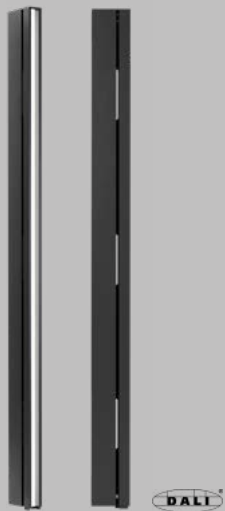
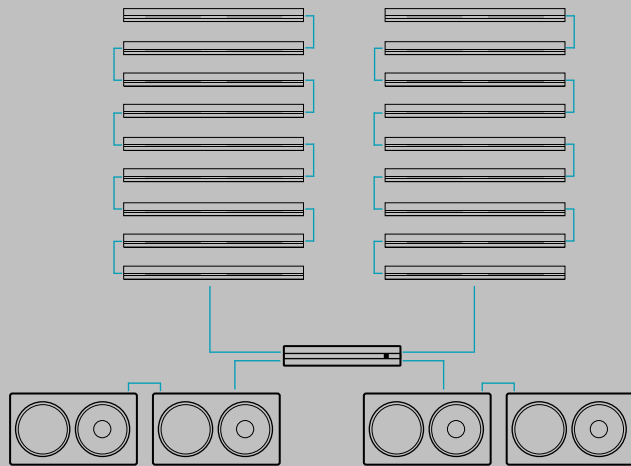

**R120-DF-D-DL-B-AU**

Speaker + Light  
1190x35x92 mm  
3 kg



**Rumble-S-KU26**

Subwoofer  
350 x 180 x 118 mm  
5,9 kg

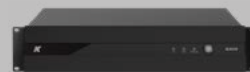

**Kommander-S-KA14**

Amplifier  
430 x 87 x 430 mm  
7,4 kg

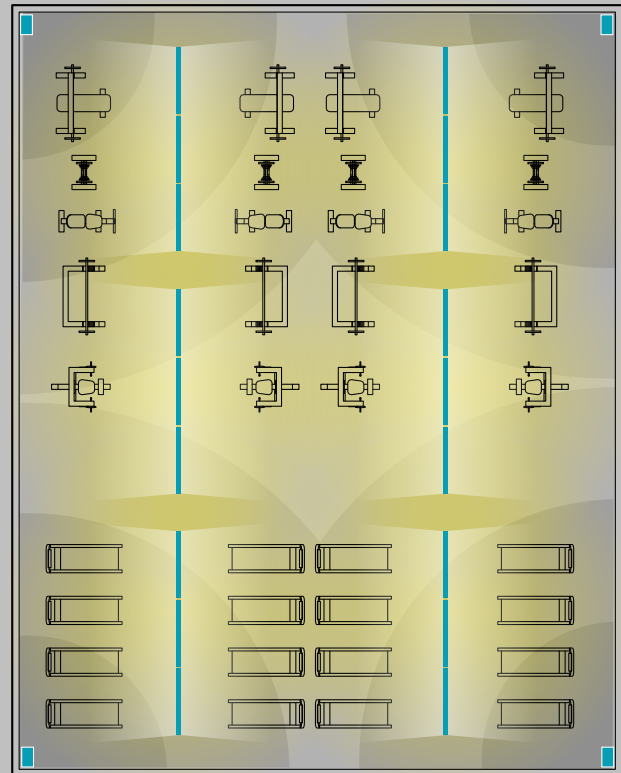

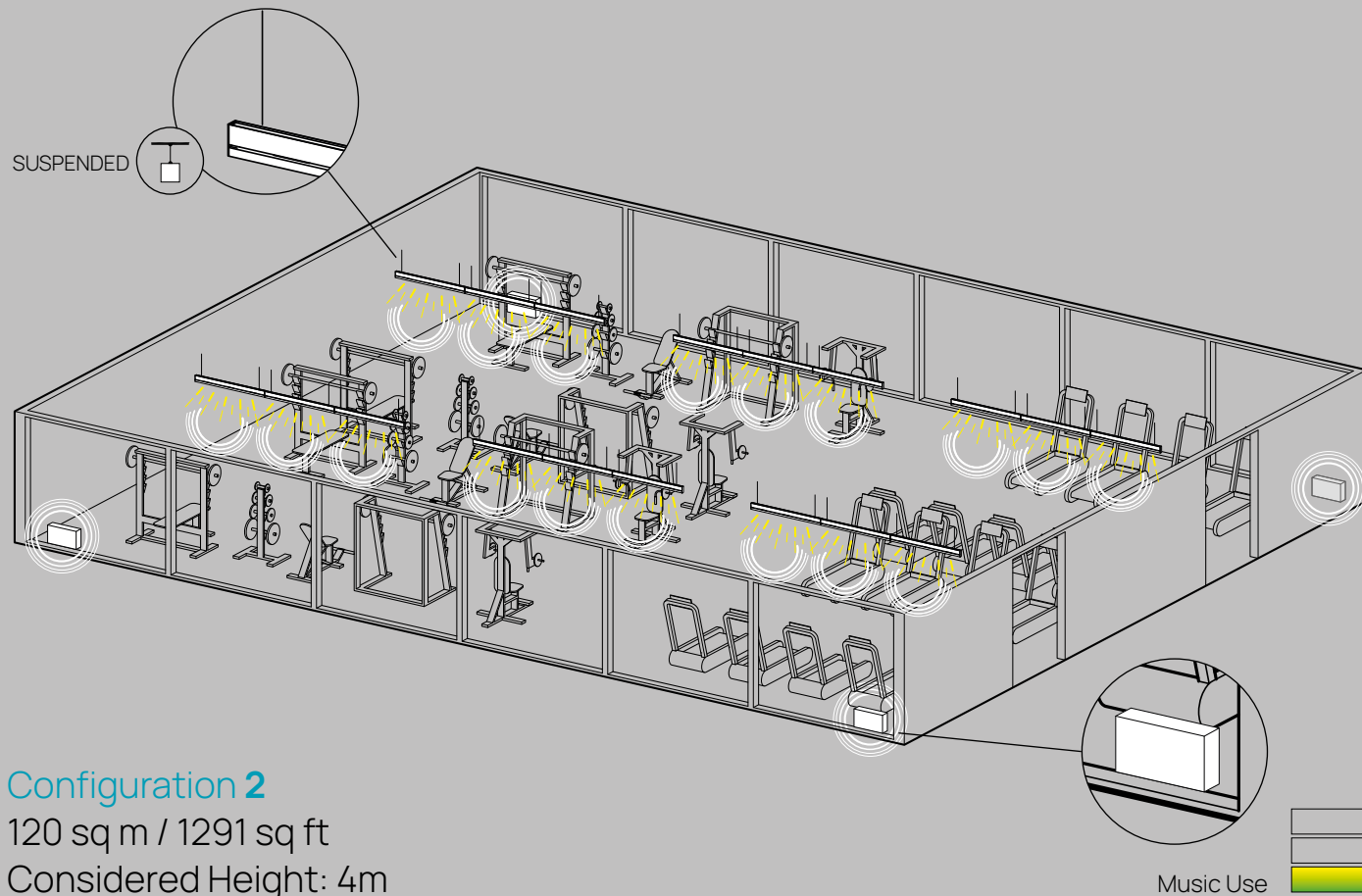

## Configuration 2

120 sq m / 1291 sq ft

Considered Height: 4m

Conf.	Area	Rail	Subwoofers	Amplifiers	Accessories
1	60 sq m (645 sq ft)	9X R120-DF-D-DL-B-AU	2x <b>Rumble-S-KU26</b>	1x <b>Kommander-S-KA14 I</b>	3x S-AL200-24 6x RTB 9x PEN2-120
2	120 sq m (1291 sq ft)	18X R120-DF-D-DL-B-AU	4x <b>Rumble-S-KU26</b>	1x <b>Kommander-S-KA14 I</b>	6x S-AL200-24 12x RTB 18x PEN2-120
3	180 sq m (1937 sq ft)	24X R120-DF-D-DL-B-AU	2x <b>Rumble-S-KU26</b>	1x <b>Kommander-S-KA28</b>	6x S-AL200-24 12x RTB 24X PEN2-120

## Are you in these professional categories?

- System Integrator
- Installer
- Rental Company
- Designer

A dark gray world map is centered in the background of the lower half of the advertisement. The map shows the outlines of continents and some internal country borders.

# BE PART OF THE SOLUTION

Join our network  
of certified pros  
to be listed within  
our partner



[www.k-array.com/en/distributors](http://www.k-array.com/en/distributors)



43°57'00"N-11°22'59.88"E

# AN AUTHENTIC PLACE



## K-ARRAY WARRANTY

K-array surl warrants its products against defects in material or workmanship. The term of the K-array surl Warranty is **five years** from the original date of purchase of the product and their accessories. This warranty may be transferred to a subsequent owner during the warranty period. However, such a transfer shall not extend the warranty period beyond the original warranty period of five years from the original date of purchase stated on the invoice from the distributor to the end client.



## IMPORTANT:

The configurations showcased in this Catalog are just examples, they don't represent existing projects. While not representing real projects, they can serve as inspiration for what's possible.

Dive into our K-array Lookbook to explore specific, well-designed audio projects. Have a project to share? Send your materials to [marketing@k-array.com](mailto:marketing@k-array.com), it might be selected for our next Lookbook.

### LEGEND:



Speakers

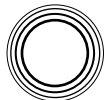

Subwoofers



Lights

---

In accordance with its policy of continuous product development, K-array reserves the right to introduce any changes to its products without prior notice. Materials, colors and data presented in the catalog are only for reference. K-array is available to customize systems, finishes and new applications upon request.

All rights reserved © 2024



[www.k-array.com](http://www.k-array.com)



[www.kgear.it](http://www.kgear.it)



[www.kscape.it](http://www.kscape.it)





**HOSPITALITY  
& LEISURE**  
APPLICATIONS





Designed and Made in Italy

K-ARRAY srl  
Via P. Romagnoli 17 | 50038 Scarperia e San Piero - Firenze - Italy  
T +39 055 84 87 222 | info@k-array.com

[www.kgear.it](http://www.kgear.it) | [www.k-array.com](http://www.k-array.com) | [www.kscape.it](http://www.kscape.it)